

**VIEWWORKS**

# VPS-245MX2 User Manual

VPS-245MX2-M/C12H00



**CoaPress®**

© 2025 Vieworks. All rights reserved.

The copyright of this document belongs to Vieworks Co., Ltd., and in accordance with copyright law, all or part of this document may not be copied, reprinted, or extracted without the permission of Vieworks Co., Ltd. Specifications and related information in this document may change without notice. Please refer to the latest version of the manual on the download website provided by our company. (<http://vision.vieworks.com>)

## Table of Contents

<b>1.</b>	<b>Instruction.....</b>	<b>5</b>
<b>1.1</b>	<b>Document Guide .....</b>	<b>6</b>
1.1.1	Target Audience.....	6
1.1.2	Symbols.....	6
1.1.3	Notations.....	6
<b>1.2</b>	<b>Precautions.....</b>	<b>7</b>
<b>1.3</b>	<b>Product Use.....</b>	<b>9</b>
1.3.1	Warrant Coverage.....	9
1.3.2	KCC Statement .....	9
<b>1.4</b>	<b>Revision History .....</b>	<b>10</b>
<b>2.</b>	<b>Product.....</b>	<b>11</b>
<b>2.1</b>	<b>Product Components.....</b>	<b>12</b>
<b>2.2</b>	<b>Product Specifications.....</b>	<b>13</b>
2.2.1	Camera Block Diagram .....	15
2.2.2	Spectral Response .....	15
2.2.3	Mechanical Specification.....	16
<b>3.</b>	<b>Installation.....</b>	<b>17</b>
<b>3.1</b>	<b>Camera Connection.....</b>	<b>18</b>
3.1.1	Precaution to Center the Image Sensor .....	18
3.1.2	Precautions Regarding Blur Between Center and Periphery.....	18
3.1.3	Installing Vieworks Imaging Solution.....	18
<b>3.2</b>	<b>Camera Interface.....</b>	<b>19</b>
3.2.1	CoaXPRESS Connector.....	20
3.2.2	Power Input Receptacle .....	21
3.2.3	Control I/O Receptacle.....	22
3.2.4	Trigger/Direction Input Circuit.....	23
3.2.5	Strobe Output Circuit.....	23
<b>4.</b>	<b>Image Acquisition Control.....</b>	<b>24</b>
<b>4.1</b>	<b>Acquisition Start/Stop Command and Acquisition Mode.....</b>	<b>26</b>
<b>4.2</b>	<b>Exposure Start Trigger .....</b>	<b>27</b>
4.2.1	Trigger Source .....	27
4.2.2	Trigger Mode .....	28
4.2.3	Exposure Time Control.....	29

4.2.4	Software Trigger Signal.....	30
4.2.5	CoaXPress Trigger Signal.....	30
4.2.6	External Trigger Signal.....	31
4.2.7	Exposure Mode.....	32
<b>4.3</b>	<b>Exposure Time Setting .....</b>	<b>34</b>
<b>4.4</b>	<b>Overlap of Exposure and Readout.....</b>	<b>35</b>
4.4.1	Overlapped.....	35
4.4.2	Nonoverlapped.....	35
<b>4.5</b>	<b>Rolling Shutter .....</b>	<b>37</b>
<b>4.6</b>	<b>Maximum Configurable Frame Rate .....</b>	<b>38</b>
4.6.1	Increasing the Maximum Allowed Frame Rate.....	38
<b>5.</b>	<b>Camera Features .....</b>	<b>39</b>
<b>5.1</b>	<b>Region of Interest .....</b>	<b>40</b>
<b>5.2</b>	<b>Binning .....</b>	<b>42</b>
<b>5.3</b>	<b>Multi-ROI .....</b>	<b>44</b>
<b>5.4</b>	<b>CXP Link Configuration.....</b>	<b>46</b>
<b>5.5</b>	<b>Pixel Format .....</b>	<b>47</b>
<b>5.6</b>	<b>Data ROI (Color Only) .....</b>	<b>48</b>
<b>5.7</b>	<b>White Balance (Color Only).....</b>	<b>49</b>
5.7.1	Balance White Auto.....	49
<b>5.8</b>	<b>Gain and Black Level .....</b>	<b>50</b>
<b>5.9</b>	<b>Defective Pixel Correction .....</b>	<b>51</b>
5.9.1	Correction Method.....	51
<b>5.10</b>	<b>Flat Field Correction.....</b>	<b>52</b>
5.10.1	Flat Field Data Selector.....	54
<b>5.11</b>	<b>Timestamp .....</b>	<b>56</b>
<b>5.12</b>	<b>Event Control.....</b>	<b>57</b>
<b>5.13</b>	<b>Digital I/O Control .....</b>	<b>58</b>
5.13.2	Strobe.....	60
5.13.3	Debounce.....	61
<b>5.14</b>	<b>Timer Control .....</b>	<b>62</b>
<b>5.15</b>	<b>Cooling Control.....</b>	<b>64</b>
<b>5.16</b>	<b>Temperature Monitor .....</b>	<b>65</b>

5.17	Status LED .....	66
5.18	Test Pattern.....	67
5.19	Reverse X .....	69
5.20	Device Link Throughput Limit .....	70
5.21	Device User ID .....	71
5.22	Device Reset .....	72
5.23	Field Upgrade.....	73
5.24	User Set Control .....	74
5.25	Sequence Control .....	75
6.	Troubleshooting.....	79
6.1	Troubleshooting.....	80
7.	Appendix .....	81
7.1	Defective Pixel Map Download .....	82
7.2	Field Upgrade.....	84
7.2.1	MCU .....	84
7.2.2	FPGA .....	85
7.2.3	XML .....	86

---

# 1. Instruction

---

This section gives basic information about this manual and safe product use.

Document Guide  
Precautions  
Product Use  
Revision History

## 1.1 Document Guide

### 1.1.1 Target Audience

This manual is intended for the users who set up and operate the **VPS-245MX2-M/C12H00**.

### 1.1.2 Symbols

This product should be operated under the safety instructions with the warning or caution symbol in this manual. It is important for you to read and understand the contents to operate the products safely.

#### Caution



- This symbol is used to indicate a potentially hazardous situation that may cause death, personal injury, or substantial property damage if the instructions are ignored. Users should be well acquainted with this symbol and the related contents.

#### Information



- This symbol is used for indicating product related references and supplementary information. Users are recommended to read the sentences with this notice carefully.

### 1.1.3 Notations

#### Bold Types

Words in bold indicate products terms, or the sentences which are needed to transmit clear meaning to the customers.



- Among the references specified in this document, some installations and settings are performed by qualified service engineers. For proper product installation and setup, please check the manuals listed in the references or contact your service engineer.

## 1.2 Precautions

### General



- Do not drop, disassemble, repair or alter the device. Doing so may damage the camera electronics and cause an electric shock.
- For safety, do not store the product where it can be accessed by children or pets.
- Stop using the device and contact the nearest dealer or manufacturer for technical assistance if liquid such as water, drinks or chemicals gets into the device.
- Do not touch the device with wet hands. Doing so may cause an electric shock.
- Make sure that the temperature of the camera does not exceed the temperature range indicated in <2.2 Product Specification>. Otherwise the device may be damaged by extreme temperatures.

### Installation and Maintenance



- Do not install in dusty or dirty areas – or near an air conditioner or heater to reduce the risk of damage to the device.
- Avoid installing and operating in an extreme environment where vibration, heat, humidity, dust, strong magnetic fields, explosive/corrosive mists or gases are present.
- Do not apply excessive vibration and shock to the device. This may damage the device.
- Avoid direct exposure to a high intensity light source. This may damage the image sensor.
- Do not install the device under unstable lighting conditions. Severe lighting change will affect the quality of the image produced by the device.
- Do not use solvents or thinners to clean the surface of the device. This can damage the surface finish.

### Power Supply



- Applying incorrect power can damage the camera. If the voltage applied to the camera is greater or less than the camera's nominal voltage, the camera may be damaged or operate erratically. Please refer to <2.2 Product Specification> for the camera's nominal voltage.
  - ※ Vieworks Co., Ltd. does NOT provide power supplies with the devices.
- Make sure the power is turned off before connecting the power cord to the camera. Otherwise, damage to the camera may result.

### Cleaning the Sensor Surface

Avoid cleaning the surface of the camera's sensor if possible. If you have dust or foreign matter on the sensor surface, use a soft lint free cotton bud dampened with a small quantity of high-quality lens cleaner. Because electrostatic discharge (ESD) can damage the sensor, you must use a cloth (e.g. cotton) that will not generate static during cleaning.



---

**Avoid dust or foreign matter on the sensor surface.**

- The camera is shipped with a protective plastic seal on the camera front. To prevent collecting dust or foreign matter on the camera sensor, make sure that you always put the protective seal in place when there is no lens mounted on the camera. In addition, make sure to always point the camera downward when there is no protective seal on the camera front or no lens mounted.

---

**Procedure for Cleaning the Sensor**

If you have dust or foreign matter on the sensor surface, follow the procedure below to wipe off:

- 1 Remove a contaminant by using an ionizing air gun.

If this step does not remove the contaminant, proceed to the next step.

- 2 Clean the contaminant on the sensor using one drop of lens cleaner on a non-fluffy cotton bud.
- 3 Wipe the cotton bud gently in only one direction (either left to right or right to left). Avoid wiping back and forth with the same cotton bud in order to ensure that the contaminants are removed and not simply transferred to a new location on the sensor surface.
- 4 Mount a lens, set the lens at a smaller aperture (e.g. F8), and then acquire images under bright lighting conditions. Check the images on the monitor for dark spots or stripes caused by the contaminant. Repeat the steps above until there is no contaminant present.



- 
- If the sensor is damaged due to electrostatic discharge or the sensor surface is scratched during cleaning, the warranty is void.
-

## 1.3 Product Use

### 1.3.1 Warrant Coverage

The following cases are excluded from the warranty coverage:

- The manufacturer is not responsible for equipment failures caused by services or modifications performed by unauthorized manufacturers, agents, or technicians.
  - The manufacturer is not liable for the loss or damage of data due to operator error.
  - Warranty coverage is void if the product is used for purposes other than its intended use, subjected to excessive use, or damaged due to negligence.
  - Damage or malfunction caused by incorrect power usage or failure to follow the operating conditions specified in the user manual is not covered.
- Natural disasters, such as lightning, earthquakes, fires, and floods, are not covered under the warranty.
- If components or software of the equipment are replaced or modified without authorization, any resulting issues are not covered by the warranty.

For product-related inquiries or service requests, please contact the seller or the manufacturer.

The warranty period is as specified in the warranty certificate at the time of purchase and is effective from the date the equipment is shipped.

### 1.3.2 KCC Statement

Type	Description
<b>Class A</b> (Broadcasting Communication Device for Office Use)	This device obtained EMC registration for office use (Class A), and may be used in places other than home. Sellers and/or users need to take note of this.

## 1.4 Revision History

Version	Date	Description
1.0	2026-05-26	Initial release



---

## 2. Product

---

This section gives instructions about the product components and their specifications.

Product Components

Product Specification

## 2.1 Product Components

### Product Components



VPS-245MX2-M/C12H00 Camera

## 2.2 Product Specifications

The VPS-245MX2-M/C12H00 camera is a new addition to the VPS series, designed for industrial applications, and features a 245-megapixel resolution with CoaXPress interface. It adopts Sony's CMOS image sensor technology (IMX811) and is capable of capturing images at a resolution of 19,200 × 12,800 at up to 12.4 frames per second.

It can transmit image data at up to 50 Gbps via CoaXPress 2.0(CXP-12) interface using 4 Coax cables and delivers uniform image along with high-speed image processing capabilities, making it ideal for demanding applications such as FPD, PCB, and semiconductor inspection.

### Main features

- High Speed 245 Megapixel CMOS Image Sensor
- CoaXPress 2.0 Interface up to 12.4 fps at 50 Gbps using 4 channels
- Output Channel: CXP-6, CXP-10, and CXP-12, each supporting 1, 2, and 4 channels
- Electronic Exposure Time Control (Rolling Shutter)
- Output Pixel Format: 8/10/12/14/16 bit for both mono and color.
- Defective Pixel Correction
- Gain / Black Level Control
- Test Pattern
- Temperature Monitor
- Field Upgrade
- Flat Field Correction

The specification of the VPS-245MX2-M/C12H00 camera is as follows:

Specification		VPS-245MX2-M/C12H00
Resolution (H × V)		19,200 × 12,800
Sensor		SONY IMX811
Sensor Size (diagonal)		64.84 mm
Sensor Type		Back-Illuminated CMOS Image Sensor
Pixel Size		2.81 $\mu\text{m}$ × 2.81 $\mu\text{m}$
Interface		CoaXPress 2.0 (CXP-12, 4 CH)
Exposure Time		98 $\mu\text{s}$ to 59.6 s (1 $\mu\text{s}$ step)
Max. Frame Rate		12.43fps at 8, 10, and 12 bit 10.56fps at 14 bit 5.31fps at 16 bit
Pixel Data	Mono	8 / 10 / 12 / 14/ 16 bit
Format	Color (RG Bayer)	8 / 10 / 12 / 14/ 16 bit
Electronic Shutter		Rolling Shutter
Digital Gain Control		x1 to x32
Analog Gain Control		x1 to x16
Black Level Control		0 to 4095 LSB at 16 bit (1 LSB step)
Trigger Synchronization		Free-run, Hardware Trigger, Software Trigger or CXP
Software Trigger		Asynchronous, Programmable via Camera API
Dynamic Range		76dB@14 bit / 78 dB@16 bit
Dimension / Weight		110 x 110 x 88.0 mm / 1,380 g
Environmental Temperature		Operating: 0°C to 40°C, Storage: -40°C to 70°C
Lens Mount		M72 mount
Power	External	11 to 24 V DC
	Dissipation	Typical. 37W
Compliance		CE, FCC, KC
API SDK		Vieworks Imaging Solution 7.x

**Table 2-1 The Specification of VPS-245MX2-M/C12H00**

### 2.2.1 Camera Block Diagram

The block diagram of the VPS-245MX2-M/C12H00 camera is as shown below:

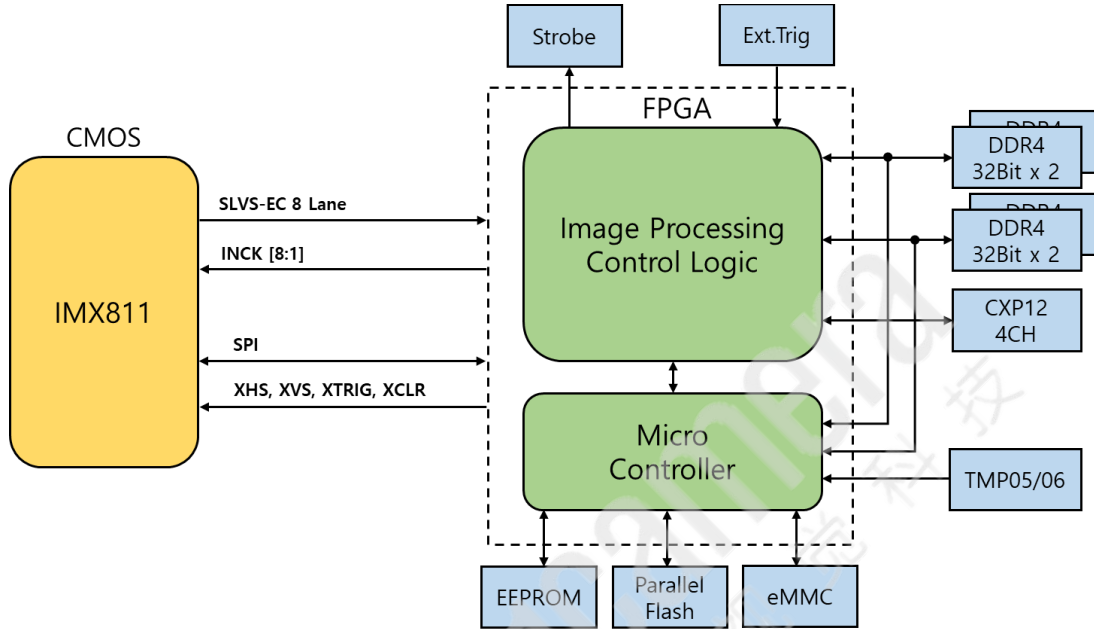

Figure 2-1 Camera Block Diagram

### 2.2.2 Spectral Response

The graph below represents the spectral response of the VPS-245MX2-M/C12H00 camera.

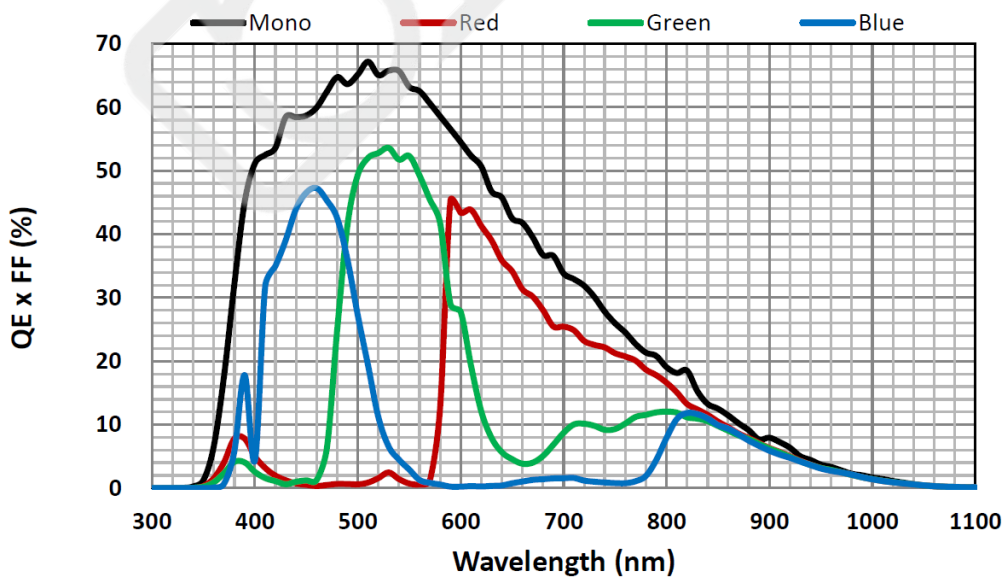

Figure 2-2 Quantum Efficiency

### 2.2.3 Mechanical Specification

Unit: mm

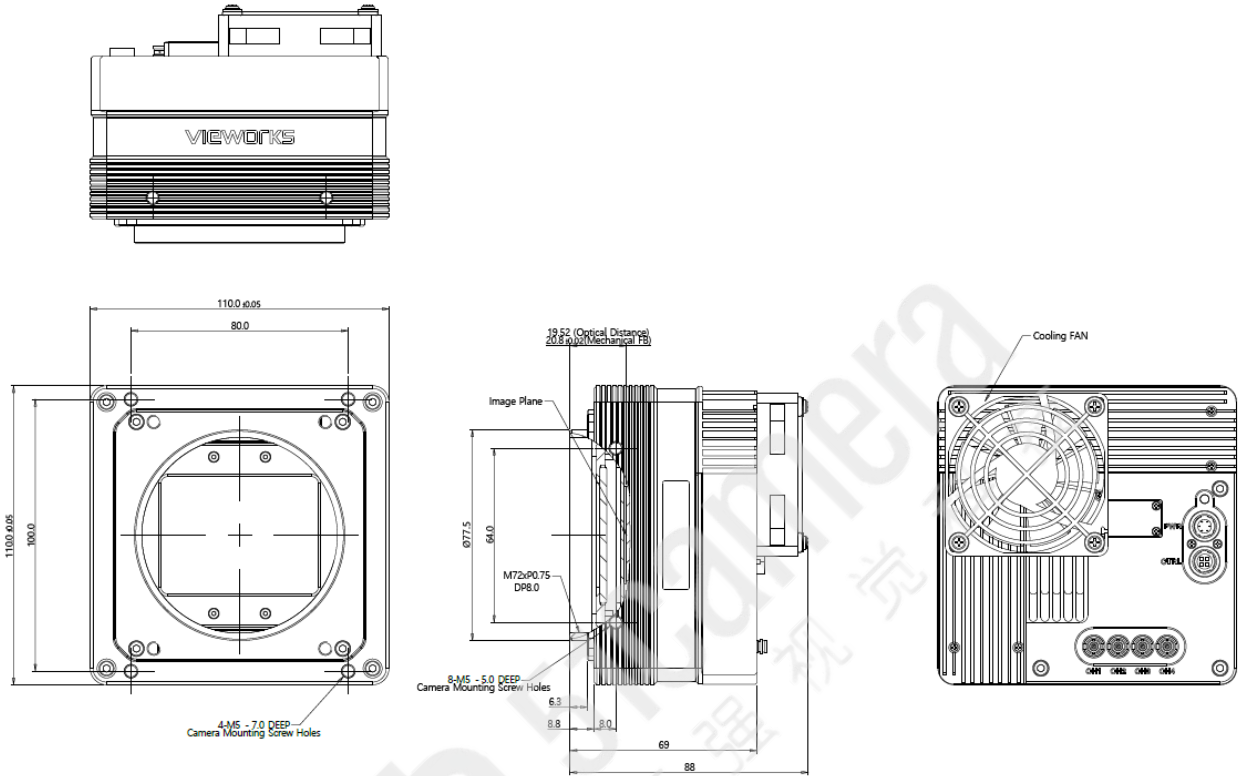

Figure 2-3 Mechanical Dimension of the VPS-245MX2 model

---

## 3. Installation

---

This section explains how to install and connect the camera.

Camera Connection

Camera Interface

## 3.1 Camera Connection

The following instructions assume that you have installed a CoaXPress Frame Grabber (hereinafter 'CXP Frame Grabber') in your computer including related software. The procedure below also assumes that you may attempt to configure two links between a camera and CXP Frame Grabber by using four coax cables. For more detailed information, refer to your CXP Frame Grabber User Manual.

To connect the camera to your computer, follow the steps below:

- 1 Plug one end of a coax cable into the CH1 of the CXP connector on the camera and the other end of the coax cable into the CH1 of the CXP Frame Grabber in your computer. Then, connect the CH2, CH3 and CH4 of the CXP connector on the camera to the CH2, CH3 and CH4 of the CXP Frame Grabber respectively using the other three coax cables.
- 2 Connect the plug of the power adapter into the 6-pin power input receptacle on the camera.
- 3 Plug the power adapter into a working electrical outlet.

### 3.1.1 Precaution to Center the Image Sensor

- User does not need to center the image sensor as it is adjusted as factory default settings.
- When you need to adjust the center of the image sensor, please contact your local dealer or the manufacturer for technical assistance.

### 3.1.2 Precautions Regarding Blur Between Center and Periphery

- Users do not need to adjust the tilt as it is adjusted as factory default settings.
- If the tilt settings need to be adjusted inevitably, please contact your local dealer or factory representative for technical support.

### 3.1.3 Installing Vieworks Imaging Solution

You can download the Vieworks Imaging Solution at <http://www.vieworks.com>. You should perform the software installation first and then the hardware installation.

### 3.2 Camera Interface

As shown in the figure below, three types of connectors and an LED indicator are located on the back of the camera and have the functions as follows:

No.	Item	Description
1	CoaXPress connector	Transmits video data and controls the camera.
2	Status LED	Displays power status and operation mode.
3	6 pin power input receptacle	Supplies power to the camera
4	4 pin control I/O receptacle	Inputs external trigger signal and outputs strobe

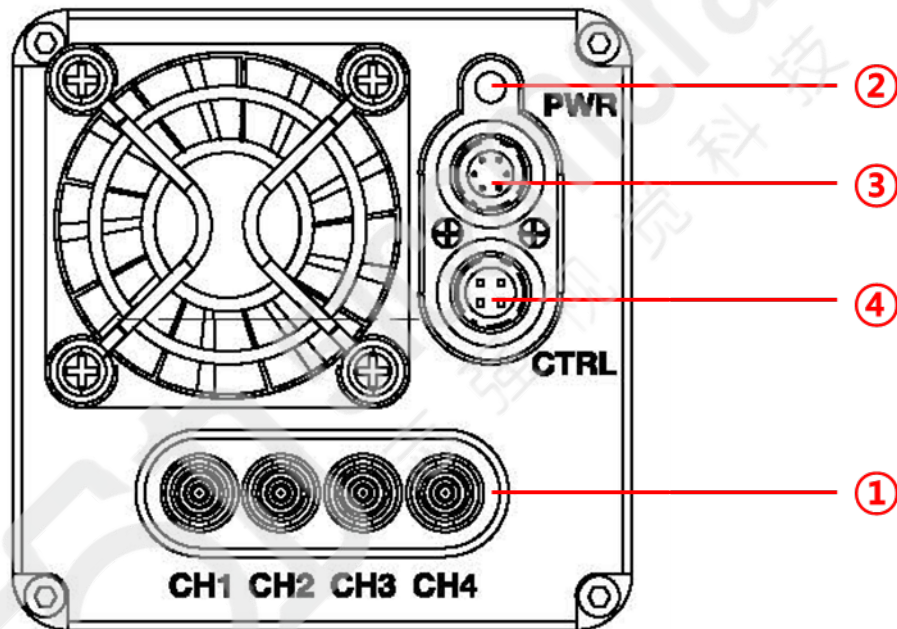

Figure 3-1 VPS-245MX2 Back Panel

### 3.2.1 CoaXPress Connector

CoaXPress protocol includes an automatic link detection mechanism (Plug and Play) to correctly detect the camera to the CXP Frame Grabber connection. The connection between the camera and CXP Frame Grabber uses a coax (also known as 'coaxial') cable and provides up to 12.5 Gbps bit rate per cable.

#### CoaXPress Micro-BNC Connector (75 Ω Micro-BNC Receptacle)

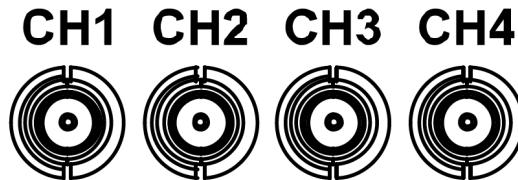

Figure 3-2 CoaXPress Micro-BNC Connector

The CoaXPress connector of the VC CXP camera complies with the CoaXPress standard, and the channel configuration of the connector is as shown in the following table:

Channel	Max. Bit Rate per Coax	Type
CH1	12.5 Gbps	Master Connection
CH2	12.5 Gbps	Extension Connection
CH3	12.5 Gbps	Extension Connection
CH4	12.5 Gbps	Extension Connection

Table 3-1 CoaXPress Connector Pin Configuration of the VC CXP Camera



- When connecting the CXP Frame Grabber and the camera using coaxial cables (also referred to as "coax cables"), pay close attention to the connection positions. If the camera's CXP connectors (CH1, CH2, CH3, and CH4) are not properly connected to the corresponding channels (CH1, CH2, CH3, and CH4) on the CXP Frame Grabber, the camera's image may not be displayed correctly, or communication between the PC and the camera may not function properly.

### 3.2.2 Power Input Receptacle

The power input receptacle is a Hirose 6-pin connector (part # HR10A-7R-6PB). The pin assignments and configurations are as follows:

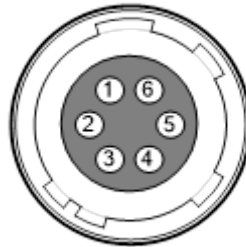

Figure 3-3 Pin Assignments for Power Input Receptacle

Pin Number	Signal	Type	Description
1, 2, 3	+12V DC	Input	DC Power Input
4, 5, 6	DC Ground -	Input	DC Ground

Table 3-2 Pin Arrangements for Power Input Receptacle



- A recommended mating connector for the Hirose 6-pin connector is the Hirose 6-pin plug (part # HR10A-7P-6S) or the equivalent connectors.
- It is recommended that you use the power adapter, which has at least 3 A current output at 11 to 24 V DC output (You need to purchase a power adapter separately.).



- Make sure the power is turned off before connecting the power cord to the camera. Otherwise, damage to the camera may result.
- If the voltage applied to the camera is greater than specified in the specifications, damage to the camera may result.

### 3.2.3 Control I/O Receptacle

The control I/O receptacle is a Hirose 4-pin connector (part # HR10A-7R-4S) and consists of an external trigger signal input and strobe output ports. The pin assignments and configurations are as follows:

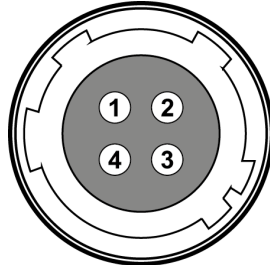

Figure 3-4 Pin Assignments for 4-pin Control I/O Receptacle

Pin Number	Signal	Type	Description
1	Trigger Input+	Input	3.3 V to 24.0 V TTL Input
2	Trigger Input-	Input	-
3	DC Ground	-	DC Ground
4	Line1 Output	Output	3.3 V TTL Output Output Resistance: 47 $\Omega$

Table 3-3 Pin Arrangements for Control I/O Receptacle



- A recommended mating connector for the Hirose 4-pin connector is the Hirose 4-pin plug (part # HR10A-7P-4P) or the equivalent connectors.

### 3.2.4 Trigger/Direction Input Circuit

The following figure shows trigger signal input circuit of the 4 pin connector. Transmitted trigger signal is applied to the internal circuit through a photo coupler. With the Debounce feature, you can specify the width of input signal to be considered as a valid input signal. An external trigger circuit example is as shown below:

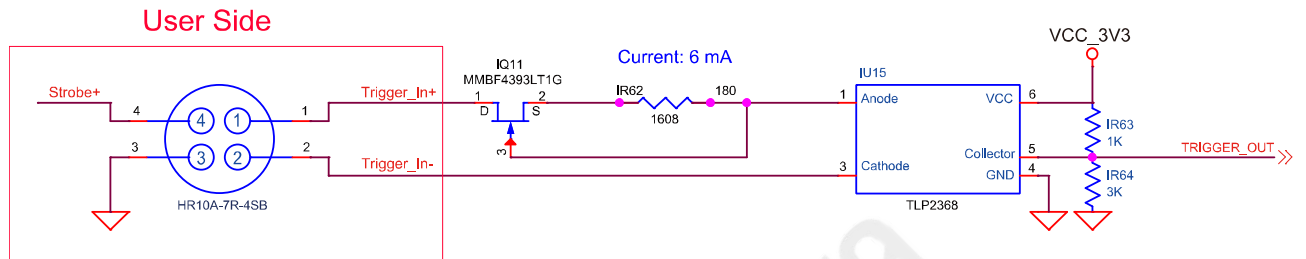

Figure 3-5 Trigger / Direction Input Schematic

### 3.2.5 Strobe Output Circuit

The strobe output signal comes out through a 3.3 V output level of TTL Driver IC. A pulse width of signal is synchronized with an exposure (shutter) signal of the camera.

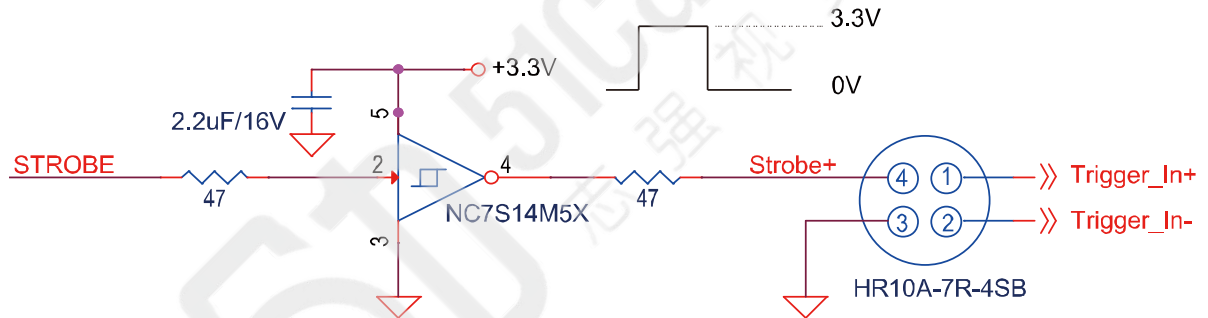

Figure 3-6 Strobe Output Schematic

---

## 4. Image Acquisition Control

---

This section provides information on image acquisition control.

Acquisition Start/Stop Command and Acquisition Mode

Exposure Start Trigger

Exposure Time Setting

Overlap of Exposure and Readout

Rolling Shutter

Maximum Configurable Frame Rate

This section provides detailed information on the following items required for image acquisition:

- Image acquisition trigger methods
- Exposure time settings
- Frame rate control
- Maximum frame rate variation based on camera settings

The key factors required to control image acquisition are as follows:

- Acquisition Start/Stop Command and Acquisition Mode
- Exposure Start Trigger
- Exposure Time Setting
- Overlap of Exposure and Readout
- Rolling Shutter
- Maximum Configurable Frame Rate



- In this section, the term "frame" generally refers to a single captured image.

## 4.1 Acquisition Start/Stop Command and Acquisition Mode

The Acquisition Start/Stop command is directly affected by the Acquisition Mode parameters. The camera starts acquiring frames once the **Acquisition Start** command is executed.

The VPS-245MX2 camera only supports **Continuous** for the Acquisition Mode parameter. Therefore, it keeps acquiring images until the **Acquisition Stop** is executed.



- The Acquisition Start command remains active until the Acquisition Stop command is executed. Once the Acquisition Stop command is executed, the camera will not be able to acquire images until a new Acquisition Start command is issued. If a user executes Acquisition Stop while the camera is in the process of acquiring images, the current image acquisition will be completed before the process stops.

## 4.2 Exposure Start Trigger

The camera deactivates the standby status when receiving the Exposure Start trigger to start exposure and readout the frame. The camera will return to the standby status once it is ready to receive the next Exposure Start trigger signal. When a new Exposure Start trigger signal is supplied to the camera in this state, the camera will begin the next exposure.

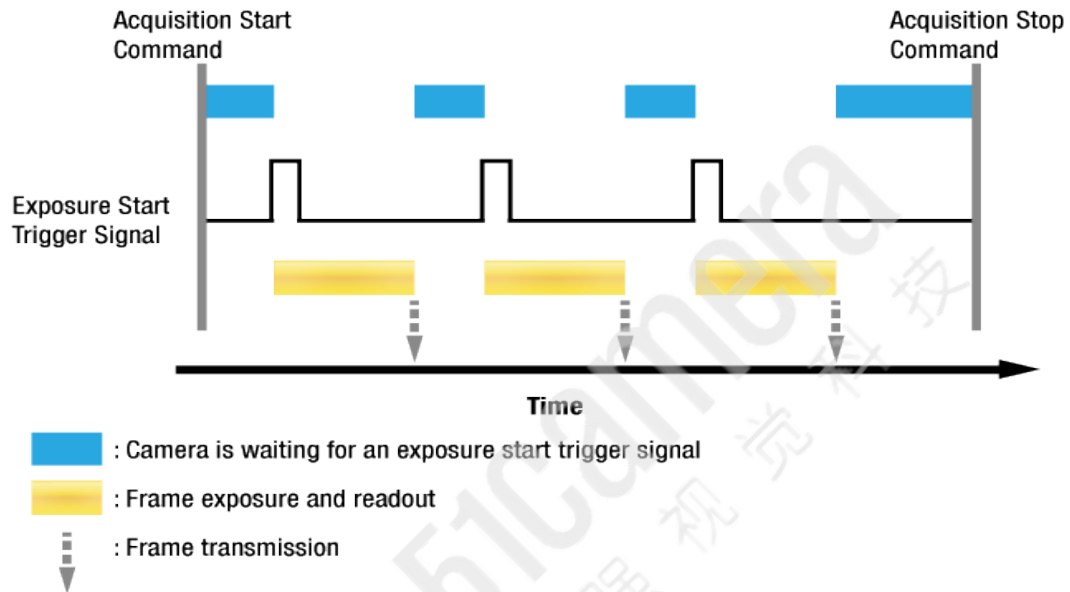

Figure 4-1 Exposure Start Trigger

### 4.2.1 Trigger Source

Exposure Start trigger can either generate signal internally or supply signals externally using one of the following 5 methods:

- Software
- UserOutput0
- LinkTrigger0
- Time0Active
- Line0 (or Hardware)

#### Software

To supply a trigger signal with Software, the Trigger Source parameter should be set to Software. Then the Exposure Start trigger is supplied to the camera every time the Trigger Software command is executed.

#### UserOutput0

To supply a user-defined (User Output) Exposure Start trigger signal to the camera, set the Trigger Source parameter to UserOutput0. Then, you can provide the Exposure Start trigger signal to the camera by toggling the User Output Value parameter to On (rising edge) or Off (falling edge).

#### LinkTrigger0

To supply a trigger signal via CH1 channel of the frame grabber, the Trigger Source parameter should be set to LinkTrigger0. Then, you can use the API provided by the CXP-12 frame grabber manufacturer to supply the CoaXPress trigger signal to the camera as an Exposure Start trigger signal. For more details, refer to the CXP-12 frame grabber user manual.

### Timer0Active

To supply a trigger signal using the user-defined Timer function, set the Trigger Source parameter to Timer0 Active. If you set the Timer Trigger Source parameter to Line0 in the Counter and Timer Control category, you can use the Timer with Line0 as the source signal to provide the Exposure Start trigger signal to the camera.

### Line0 (or Hardware)

To supply a trigger signal through hardware, set the **Trigger Source** parameter to **Line0**. Then, provide an appropriate electrical signal to the camera, and the generated Exposure Start trigger signal will be recognized by the camera.

## 4.2.2 Trigger Mode

The critical parameter to the Exposure Start Trigger is Trigger Mode. This mode is configurable in 2 ways:

### a) Trigger Mode = Off

When the Trigger Mode parameter is set to Off, all required Exposure Start trigger signals are generated internally by the camera, eliminating the need for the user to supply Exposure Start trigger signals to the camera. The rate at which the camera generates these signals and captures images is determined by the settings of the frame rate-related parameters.

After setting Trigger Mode to Off and executing the Acquisition Start command, the camera will automatically generate Exposure Start trigger signals. It will continue to do so until the Acquisition Stop command is executed.



- When the Trigger Mode parameter is set to Off, the camera generates all the required trigger signals internally. With this configuration, the camera continuously captures images without the need for external trigger signals. This mode is commonly referred to as **Free-Run**.

The rate at which the camera generates **Exposure Start** trigger signals can be determined by the **Acquisition Frame Rate** parameter.

- If this parameter is set to a value lower than the maximum frame rate allowed by the current camera settings, the camera will generate Exposure Start trigger signals at the specified frame rate.
- If this parameter is set to a value higher than the maximum frame rate allowed by the current camera settings, the camera will generate Exposure Start trigger signals at the maximum allowable frame rate.

When **Trigger Mode is set to Off**, the exposure time is determined by the Exposure Time parameter. For more details, refer to <4.3 Exposure Time Setting>.

#### b) Trigger Mode = On

When the **Trigger Mode** parameter is set to **On**, the user must supply an **Exposure Start** trigger signal to the camera each time an image is to be acquired. The **Trigger Source** parameter specifies the source signal that will act as the **Exposure Start** trigger signal. In this mode, trigger signals must not be supplied at a rate faster than the maximum frame rate specified at the end of this section. If a trigger signal is supplied when the camera is not in a ready state, that signal will be ignored.

When **Trigger Mode** is **On**, and the **Trigger Source** parameter is set to **Software**, the exposure time for each image acquisition will depend on the specific trigger settings.

#### a) When LinkTrigger0 or Line0 is selected:

- Exposure Mode = Timed: Exposure time is controlled by the Exposure Time parameter.
- Exposure Mode = TriggerWidth: Exposure time can be adjusted by controlling an external trigger signal.

#### b) When Timer0Active is selected:

- Exposure Mode = Timed: Exposure time is controlled by the Exposure Time parameter.
- Exposure Mode = TriggerWidth: Exposure time is controlled by the Time Duration parameter when the Timer Trigger Activation parameter is set to Rising or Falling Edge, while it is controlled by the external trigger signal when the Timer Trigger Activation parameter is set to Level High or Level Low

#### c) When UserOutput0 is selected:

- Exposure Mode = Timed: Exposure time is controlled by the Exposure Time parameter.
- Exposure Mode = TriggerWidth: Exposure time is controlled by the activation of the User Output Value parameter.

After setting the **Trigger Source** parameter, you also need to select the **Trigger Activation** parameter from the following options:

- **Falling Edge**: Specifies that the falling edge of the electrical signal will act as the **Exposure Start** trigger.
- **Rising Edge**: Specifies that the rising edge of the electrical signal will act as the **Exposure Start** trigger.

### 4.2.3 Exposure Time Control

Image acquisition starts as the camera receives the Exposure Start trigger. An important factor in the image acquisition process is the amount of time that the camera sensor's pixels are exposed to light.

When the camera's Trigger Source is set to Software, the exposure time for each image is determined by the Exposure Time parameter. If the Trigger Source is set to UserOutput0, LinkTrigger0, Timer0 Active, or Line0, the Exposure Mode can be configured using either the Timed or TriggerWidth method.

- When set to **Timed**, the exposure time for each image is determined by the Exposure Time parameter.

- When set to **TriggerWidth**, the exposure time is determined by the rising and falling edges of **User Output**, **CoaXPress**, **Timer**, or **Hardware** signals controlled by the user. This mode is useful when different exposure times are required for each image.

#### 4.2.4 Software Trigger Signal

To start image acquisition, set the Trigger Mode parameter to On and the Trigger Source parameter to **Software** to supply the software trigger signal, exposure start, to the camera. When the camera in ready mode receives the Exposure Start trigger, exposure begins as shown in the below image. However, a new Exposure Start trigger cannot be received during the exposure. Signals can only be received when the camera is in the ready state. The exposure time for each image is determined by the Exposure Time parameter.

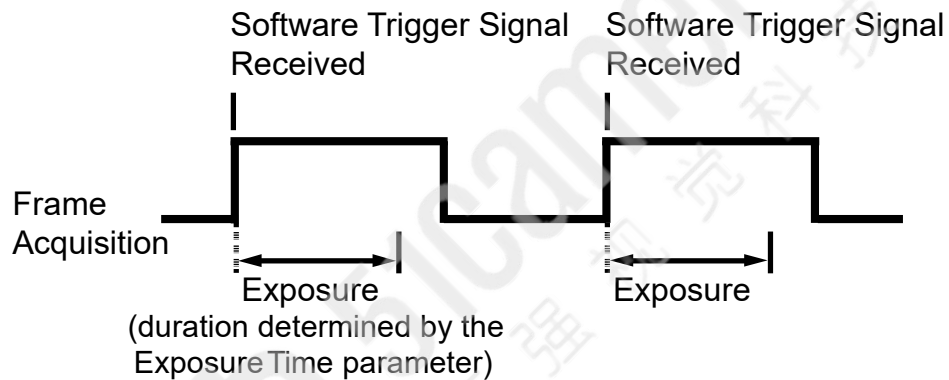

Figure 4-2 Image Acquisition with the Software Trigger Signal

The frame rate is determined by the frequency at which the user supplies software trigger signals to the camera. Trigger signals should not be supplied at a rate exceeding the maximum frame rate specified at the end of this section. The camera will not receive trigger signals if it is not in the ready state.

#### 4.2.5 CoaXPress Trigger Signal

When the Trigger Mode parameter is set to On and the Trigger Source parameter is set to LinkTrigger0, a CoaXPress trigger signal (Exposure Start) must be supplied to the camera in order to capture images. The CoaXPress trigger signal acts as the Exposure Start trigger for the camera. For more details, refer to the CXP-12 Frame Grabber User Manual.

The Trigger Activation parameter allows you to use the rising edge or falling edge of the CoaXPress signal as the image acquisition trigger. When the camera, which is waiting for a trigger, receives the signal, it will begin exposure. However, while the camera is exposed, it cannot receive a new Exposure Start trigger signal. The camera can only receive triggers when in the ready state. The formula for calculating the frame rate is as follows. For example, if the camera operates with a CXP trigger signal with a period of 50 ms (0.05 seconds), the resulting frame rate would be 20 fps.

$$\frac{1}{\text{CoaXPress signal period in seconds}} = \text{Frame Rate}$$

## 4.2.6 External Trigger Signal

If the Trigger Mode parameter is set to On and the Trigger Source parameter is set to Line0, an externally generated electrical signal injected into the external trigger input terminal will act as the Exposure Start trigger signal for the camera. This type of trigger signal is generally referred to as a hardware trigger signal.

In the **Trigger Activation** parameter, the rising edge or falling edge of the external signal can be used as the trigger for image acquisition. When the camera, in its idle state, receives the signal, exposure starts. However, a new **Exposure Start** trigger signal cannot be received while the camera is exposed to light. The camera can only receive the signal when it is in the idle state. The formula for determining the **frame rate** is as follows: For instance, if the camera is operated with an external trigger signal that has a period of 50 ms (0.05 seconds), the resulting frame rate will be 20 fps.

$$\frac{1}{\text{External signal period in seconds}} = \text{Frame Rate}$$

### Delay Time Setting

When the **Trigger Source** parameter is set to **Timer0Active**, you can configure a delay between the moment the camera receives the hardware trigger signal and when it is applied. The method for setting the delay time is as follows:

- 1 In the Counter and Timer Control category, set the Timer Trigger Source parameter to Line0.
- 2 Use the Timer Delay parameter to set the delay time.
- 3 In the Acquisition Control category, set the Trigger Source parameter to Timer0Active.
- 4 Click Acquisition Start to initiate image acquisition after the specified delay time.

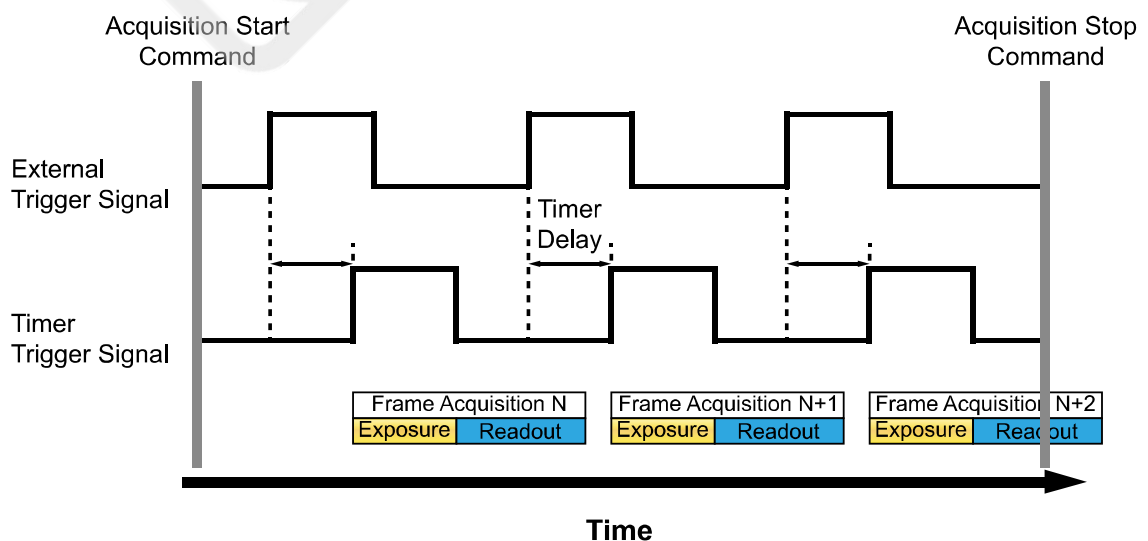

Figure 4-3 Delay Time Settings for External Trigger

## 4.2.7 Exposure Mode

When using external trigger signals, such as CoaXPress or External, as the Exposure trigger, two modes are available: **Timed** and **TriggerWidth**.

### Exposure Mode = Timed

When **Timed Mode** is selected, the exposure time required for image acquisition is determined by the **Exposure Time** parameter.

- If set to a **rising edge** trigger, the exposure time starts when the external trigger signal rises (transitions from low to high).
- If set to a **falling edge** trigger, the exposure time starts when the external trigger signal falls (transitions from high to low).

The diagram below illustrates the Timed exposure mode set with a rising edge trigger, where the exposure begins as the external trigger signal rises

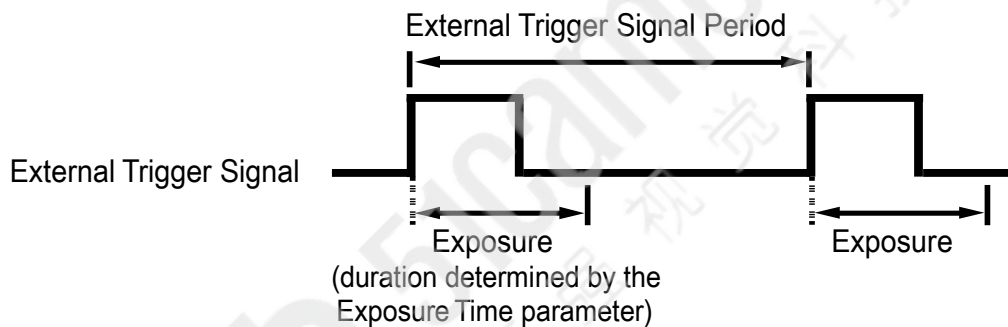

Figure 4-4 Timed Exposure Mode

If a new **Exposure Start trigger** signal is supplied while exposure is ongoing, that trigger signal will be ignored.

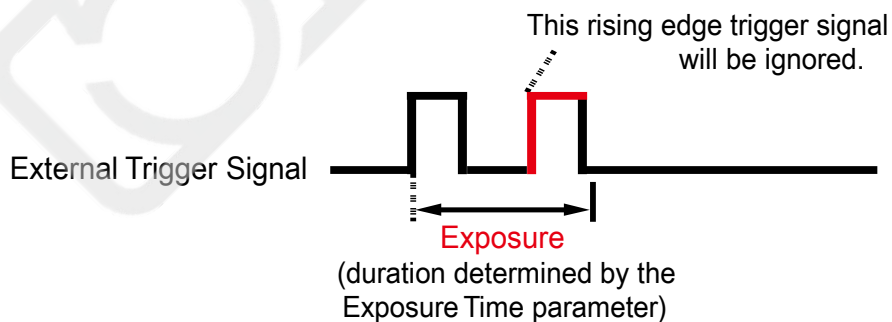

Figure 4-5 Timed Exposure mode and Overlapping Triggers

### Exposure Mode = TriggerWidth

If you select the TriggerWidth exposure mode, you can directly control the exposure period for each image acquisition using the external trigger signal (CoaXPress or External).

- When set to a rising edge trigger, exposure starts when the external trigger signal rises, and the exposure period continues until the signal falls.
- When set to a falling edge trigger, exposure starts when the external trigger signal falls, and the exposure period continues until the signal rises.

The following illustration shows the TriggerWidth exposure mode set with a rising edge trigger. TriggerWidth exposure is useful when applying different exposure periods for each image.

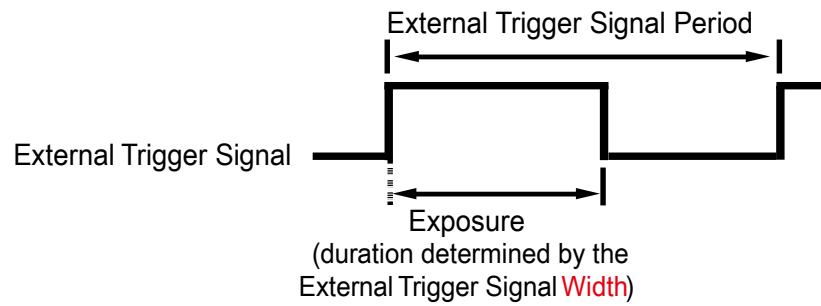

Figure 4-6 TriggerWidth Exposure Mode

### 4.3 Exposure Time Setting

This explains how to adjust the exposure time by setting the Exposure Time parameter. When the camera operates in the following ways, you need to set the Exposure Time parameter to specify the exposure duration.

- Set Trigger Mode to Off.
- Set Trigger Mode to On and Trigger Source to Software.
- Set Trigger Mode to On and Trigger Source to UserOutput0, LinkTrigger0, Timer0 Active, or Line0, and set Exposure Mode to Timed.

The Exposure Time parameter should not be set below the allowable minimum value. The Exposure Time parameter sets the exposure time in microseconds ( $\mu$ s). The camera's allowable minimum and maximum exposure times are as follows:

Camera Mode	Number of Channels	Minimum Exposure Time	Maximum Exposure Time <sup>†</sup>
VPS-245MX2-M/C12H00	4 Channels	98 $\mu$ s	60,000,000 $\mu$ s

<sup>†</sup>: When the Exposure Mode is set to **TriggerWidth**, the exposure time is determined by the duration of the trigger signal, and there is no maximum limit.

**Table 4-1 The Minimum and Maximum Exposure Time Settings**

## 4.4 Overlap of Exposure and Readout

The image is acquired through two processes. The first is the exposure of the pixels on the image sensor. Once the exposure process is completed, the second process begins, which is the readout of the pixel values from the sensor. The VPS-245MX2 camera can be operated in the Overlapped acquisition mode or the Non-overlapped acquisition mode.

### 4.4.1 Overlapped

When the Trigger Mode parameter is set to Off (Free-run mode), the camera operates with 'overlapped' acquisition so that the exposure for a new frame can be overlapped with the sensor readout for the previous frame. The exposure of a new frame begins while the camera is still reading out the sensor data for the previously acquired frame.

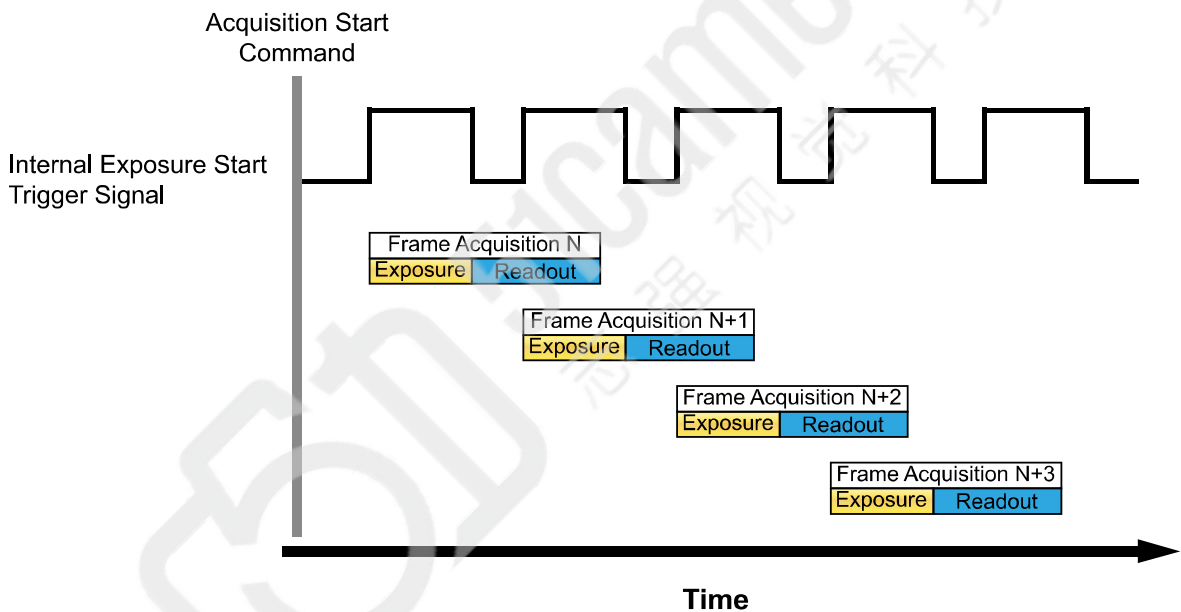

Figure 4-7 Overlapped Exposure and Readout

### 4.4.2 Nonoverlapped

While the pixel values from the previous image are being read out, if the Trigger Mode parameter is set to On, the exposure or readout process for the new image will begin. The image below illustrates the case where the Trigger Mode parameter is set to "On," the Trigger Source parameter is set to "Line0," and the Exposure Mode parameter is set to "TriggerWidth."

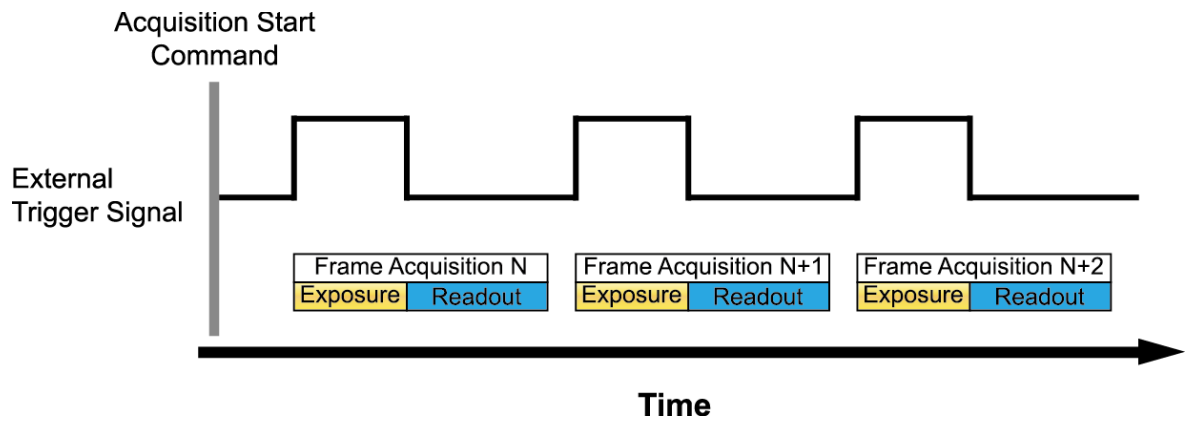
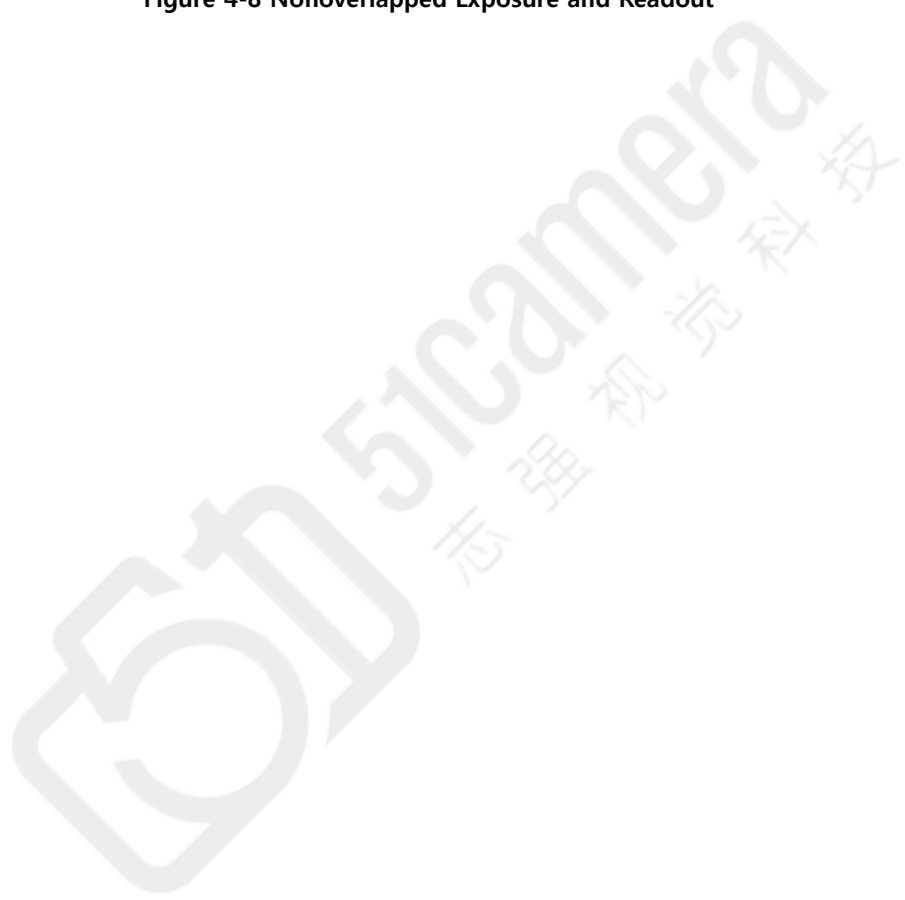

Figure 4-8 Nonoverlapped Exposure and Readout



### 4.5 Rolling Shutter

The VPS-245MX2 camera is equipped with an image sensor that has an electronic rolling shutter. The camera exposes and reads out the pixel line with a temporal offset (tRow) from one line to the next. When a trigger signal is applied to the camera, the camera resets the top line of pixels (Line 1) and begins exposing that line. The camera resets line two tRow later and begins exposing the line. And so on until the bottom line of pixels (Line N) is reached. The pixel values for each line are read out at the end of exposure for the line. The readout time for each line is identical to the tRow value.

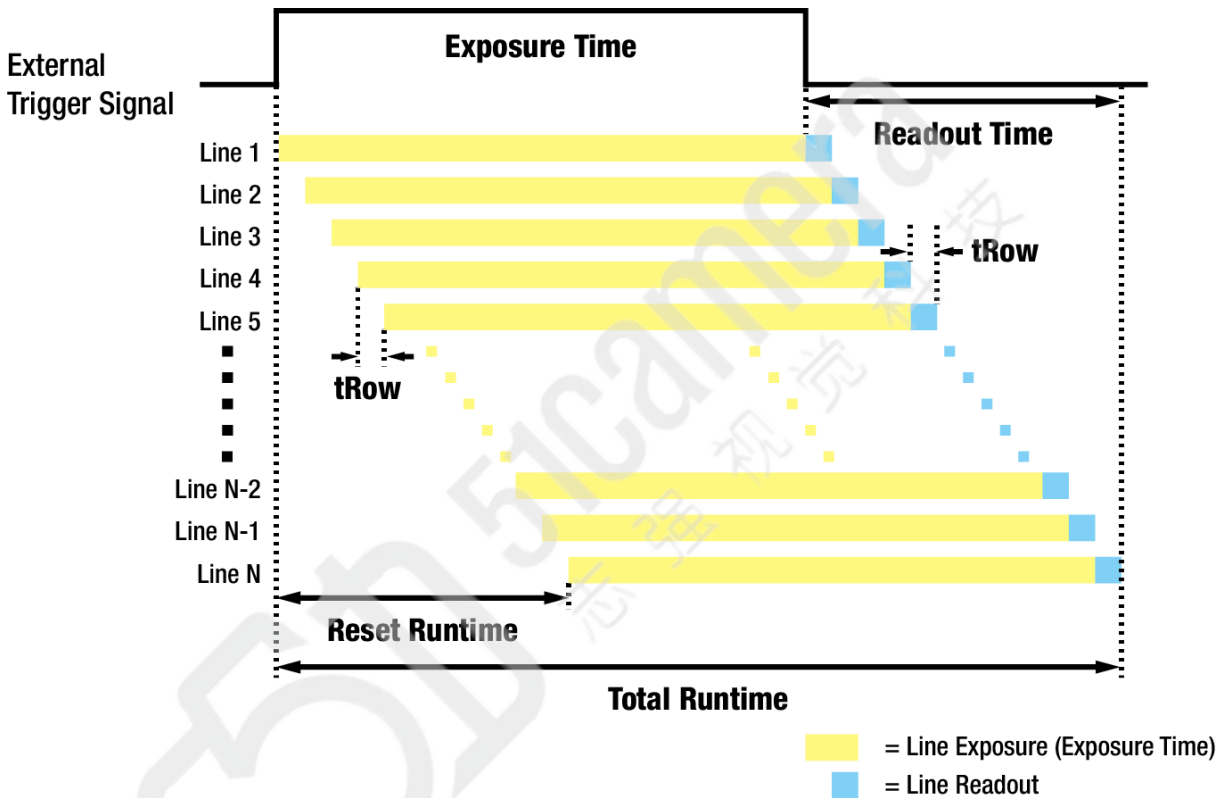

Figure 4-9 Rolling Shutter

The tRow value for the camera depending on the camera's CoaXPress setting is as follows:

Number of Channels	tRow
1 Channel	6.11 $\mu$ s
2 Channel	6.11 $\mu$ s
4 Channel	6.11 $\mu$ s

Table 4-2 Temporal Offset Values depending on the number of CXP channels



- The temporal offset values shown in the table above refer to camera operation at full resolution. These values vary when you use the binning feature or change the Image ROI settings.

## 4.6 Maximum Configurable Frame Rate

The factors that limit the camera's maximum frame rate are as follows:

- **Transmission time to the user's computer:** The transmission time is determined by the bandwidth allocated to the camera.
- **Time taken to transfer data from the image sensor to the camera's frame buffer after readout:** This time is determined by the ROI (Region of Interest) settings. A smaller image size results in a shorter readout time.
- **CXP Link Configuration:** Using more channels in the CXP Link Configuration allows for faster image acquisition compared to using fewer channels.
- **Exposure time:** Using very long exposure times reduces the number of images that can be acquired per second.

### 4.6.1 Increasing the Maximum Allowed Frame Rate

To capture images at a faster rate than the maximum allowed frame rate for the camera's current settings, adjust one or more of the following factors that affect the maximum frame rate and verify if the speed has increased.

- The time it takes to transmit images from the camera is a critical factor that limits the frame rate. Using the ROI (Region of Interest) function can reduce the image transmission time (which increases the maximum frame rate).
  - Reducing the size of the image can increase the allowable maximum frame rate. If possible, reduce the Height and Width settings of the image ROI.
- If using a CXP Link Configuration with fewer channels, switch to one with more channels. This generally increases the maximum frame rate.
- If the camera is set to capture images at maximum resolution with normal exposure time, the exposure time does not limit the frame rate. However, when using long exposure times, the exposure time can limit the maximum frame rate. When using long exposure times, reduce the exposure time and check if the maximum frame rate increases. In this case, you may need to adjust the settings by using a bright light source or opening the lens aperture to allow more light in.



- Using extremely long exposure times can significantly limit the maximum frame rate. For example, if the exposure time is set to 1 second, it takes at least 1 second to capture one image, so the camera can capture only one image per second at most.

---

## 5. Camera Features

---

This section provides information on each camera feature.

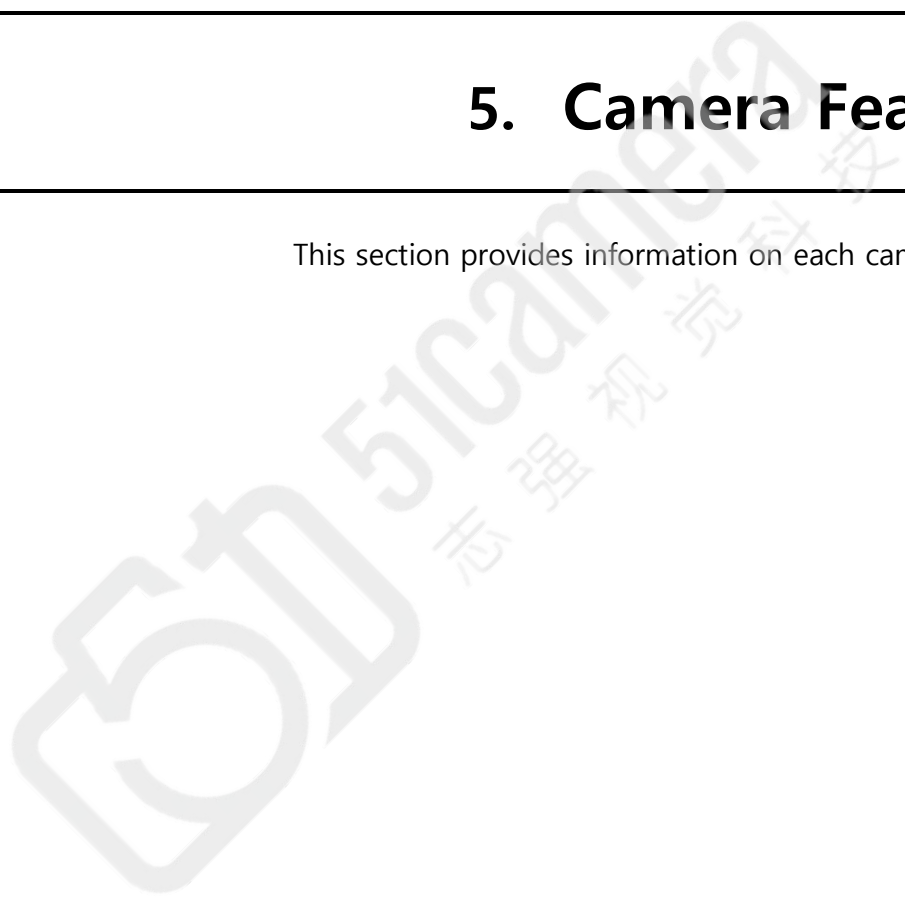

### 5.1 Region of Interest

Users can designate a Region of Interest (ROI) in the image for analysis, allowing them to capture images at a faster frame rate with the same quality as capturing the entire area. In this case, reducing the Width and Height parameters increases the maximum allowable frame rate.

When an ROI is specified, the Offset X and Offset Y values are set automatically. The VPS-245MX2 camera automatically centers the ROI at the midpoint of the sensor's X and Y axes.

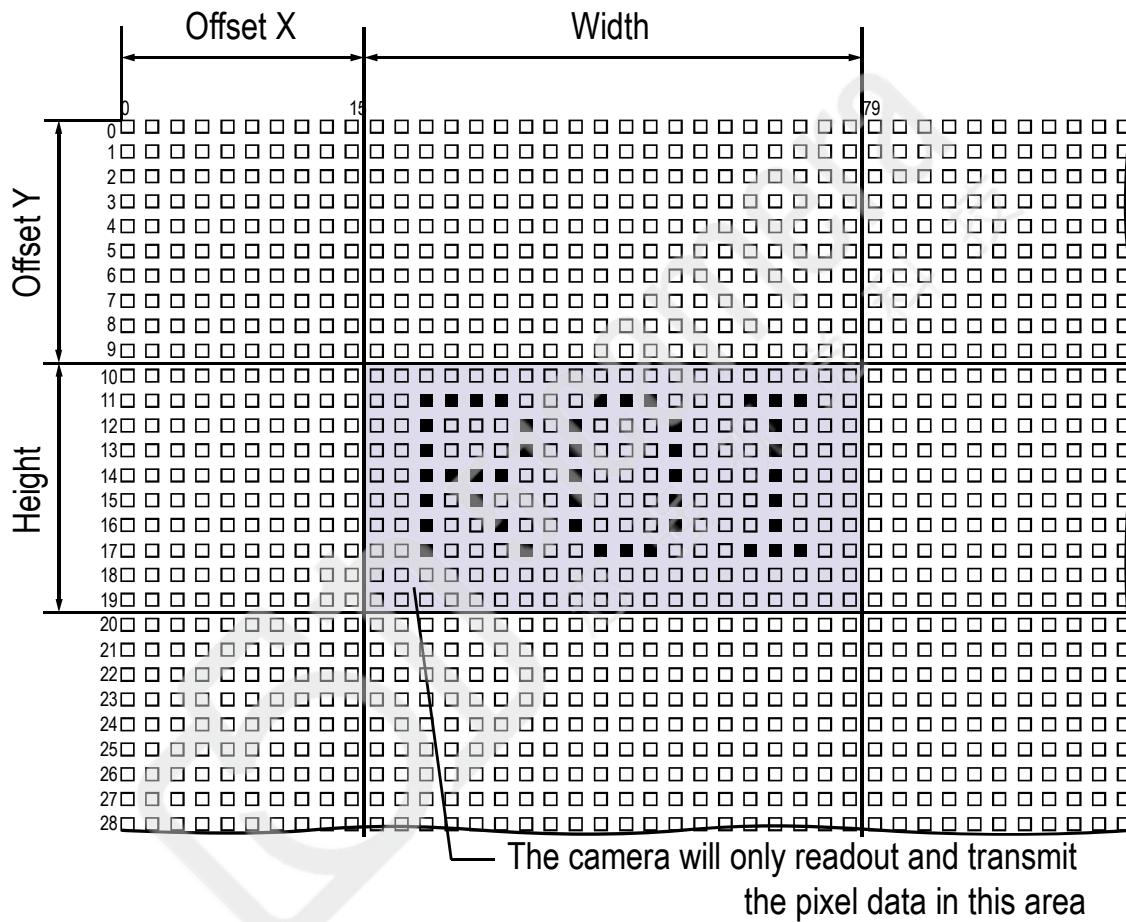

Figure 5-1 Region of Interest (Sample)

The XML parameters related to ROI settings are as follows. The units for all parameters in this table are in pixels

XML Parameter	Value	Description	
ImageFormatControl	SensorWidth <sup>a</sup>	19,200	Effective width of the sensor
	SensorHeight <sup>a</sup>	12,800	Effective height of the sensor
	WidthMax	19,200	Maximum allowed width of the image with the current camera settings
	HeightMax	12,800	Maximum allowed height of the image with the current camera settings
	Width <sup>b</sup>	128 to 19,200	Sets the Width of the Image ROI.
	Height <sup>c</sup>	8 to 12,800	Sets the Height of the Image ROI.

	OffsetX <sup>c</sup>	-	Sets the horizontal offset from the origin to the Image ROI.
	OffsetY <sup>a</sup>	-	Sets the vertical offset from the origin to the Image ROI

a: Read only. User cannot change the value.

b: User Menu for Setting ROI size

c: User Menu for setting the location of the starting point

**Table 5-1 XML Parameters for ROI**

For this product, the ROI center is always aligned with the vertical center of the sensor due to its characteristics. Therefore, the Width and Height values set for the desired ROI size are automatically adjusted to center the ROI in the image.

- In case of the VPS-245MX2 camera, the width parameter can be set to multiples of 32 and the height parameter to multiples of 8.

The minimum allowed setting values for the ROI Width and Height are shown below:

Camera Model	Minimum Width Settings	Minimum Height Settings
VPS-245MX2	128	8

**Table 5-2 Minimum ROI Width and Height Settings**

The maximum frame rates for horizontal and vertical ROI changes in the VPS-245MX2 camera are as shown below. The maximum frame rates listed below are calculated based on 8-bit settings. If you change from 8 bit to 10 bit, the speed generally decreases by approximately 20%. The frame rates shown in the table are the values output from the camera and may vary depending on the specifications of the user's computer.

ROI Size (H x W)	1 Channel	2 Channels	4 Channels
12,800 x 320	12.44	12.44	12.44
12,800 x 3008	12.44	12.44	12.44
12,800 x 7616	7.98	12.44	12.44
12,800 x 15,008	4.21	8.51	12.44
12,800 x 19,200	3.17	6.42	12.44

**Table 5-3 Maximum Frame Rate by VPS-245MX2's ROI Size\_CXP-12**



- When using ROI mode, the applicable ROI values (H × V) may vary depending on the specifications of the frame grabber. For detailed information, please refer to the CXP-12 frame grabber user manual.

## 5.2 Binning

The Binning has the effects of increasing the level value and decreasing resolution by summing the values of the adjacent pixels and sending them as one pixel. The XML parameters related to Binning are as follows:

XML Parameter	Value	Description	
ImageFormatControl	BinningSelector	Sensor	Applies the Binning in digital by the sensor.
		Logic	Applies the Binning in digital by the logic.
	BinningHorizontalMode	Sum	Adds pixel values from the adjacent pixels as specified in the Binning Horizontal, and then sends them as one pixel.
		Average	According to the Binning Selector setting: Sensor: N/A Logic: Adds pixel values from the adjacent pixels as specified in the Binning Horizontal and divides them by the number of combined pixels, and then sends them as one pixel.
	BinningHorizontal	1×, 2×, and 4×	The number of horizontal pixels to combine together. <ul style="list-style-type: none"> <li>x4 is available only when the Binning Selector is set to Logic.</li> <li>When the Binning mode is set to Sensor, the BinningHorizontal value is updated automatically according to the BinningVertical value.</li> </ul>
	BinningVerticalMode	Sum	Adds pixel values from the adjacent pixels as specified in the Binning Vertical, and then sends them as one pixel.
		Average	According to the Binning Selector setting: Sensor: N/A Logic: Adds pixel values from the adjacent pixels as specified in the Binning Vertical and divides them by the number of combined pixels, and then sends them as one pixel.
	BinningVertical	1×, 2×, and 4×	The number of vertical pixels to combine together. <ul style="list-style-type: none"> <li>x4 is available only when the Binning Selector is set to Logic.</li> </ul>

**Table 5-4 Parameters for Binning**

When 2x2 binning is enabled, the camera's resolution is reduced to one-quarter of its original size.

- When Binning Mode is set to **Sum**, it reduces both the horizontal and vertical dimensions of the image by half, resulting in a fourfold increase in brightness.
- When Binning Mode is set to **Average**, it reduces both the horizontal and vertical dimensions by half, but the brightness remains the same.

The Width Max and Height Max XML parameters, which indicate the current maximum output resolution, are automatically updated based on the binning settings. In addition, the Width, Height, Offset X, and Offset Y parameters are adjusted accordingly, allowing you to check the current camera resolution.

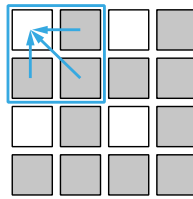

### 2 × 2 Binning

Figure 5-2 2x2 Binning



- In color mode, binning is performed by combining adjacent pixels of the same color into a single pixel.

### 5.3 Multi-ROI

The VPS-245MX2 camera's Multi-ROI feature allows you to specify up to 8 ROIs within the entire sensor area. When Multi-ROI is enabled, the camera reads out pixel data only from the specified regions during image acquisition. It then combines the data from these regions into a single image before transmitting it. The XML parameters related to Multi-ROI configuration are listed below, with all values in pixels.

XML Parameter	Value	Description	
MultiROIControl	MultiROISelector	Region0 to Region7	Selects the ROI to set.
	MultiROIMode	On/Off	Enables / Disables the selected ROI.
	MultiROIWidth	256 to 19,200	Width setting for the selected ROI
	MultiROIHeight	8 to 12,800	Height setting for the selected ROI
	MultiROIOffsetX	0 to 19,200	Horizontal offset from the origin to the selected ROI
	MultiROIOffsetY	4 to 12,796	Vertical offset from the origin to the selected ROI
	MultiROIValid <sup>a</sup>	-	Verifies the validation of the Multi-ROI setting values.
	MultiROIStatus	Active/Inactive	Displays the status of the Multi ROI feature. <ul style="list-style-type: none"> <li>Active: The Multi-ROI feature is enabled.</li> <li>Inactive: The Multi-ROI feature is disabled.</li> </ul>

a: If the setting values for the Multi-ROI feature are valid, 'True' will be returned or the check box will be selected

**Table 5-5 XML parameter for Multi-ROI**

When configuring multiple ROIs, the Multi-ROI Width parameter is applied uniformly to all ROIs, so it is recommended to set this parameter first. After that, you can configure each ROI individually. You can define up to 8 ROIs, numbered from 0 to 7. First, select the desired ROI number using the Multi-ROI Selector parameter, then enable or disable it using the Multi-ROI Mode parameter. Finally, adjust the Multi-ROI Offset Y and Multi-ROI Height parameters for each selected ROI. The figure below provides an example of configuring two ROIs.

- MultiROI Width × the total height of the three regions (Region0 Height + Region1 Height + Region2 Height)

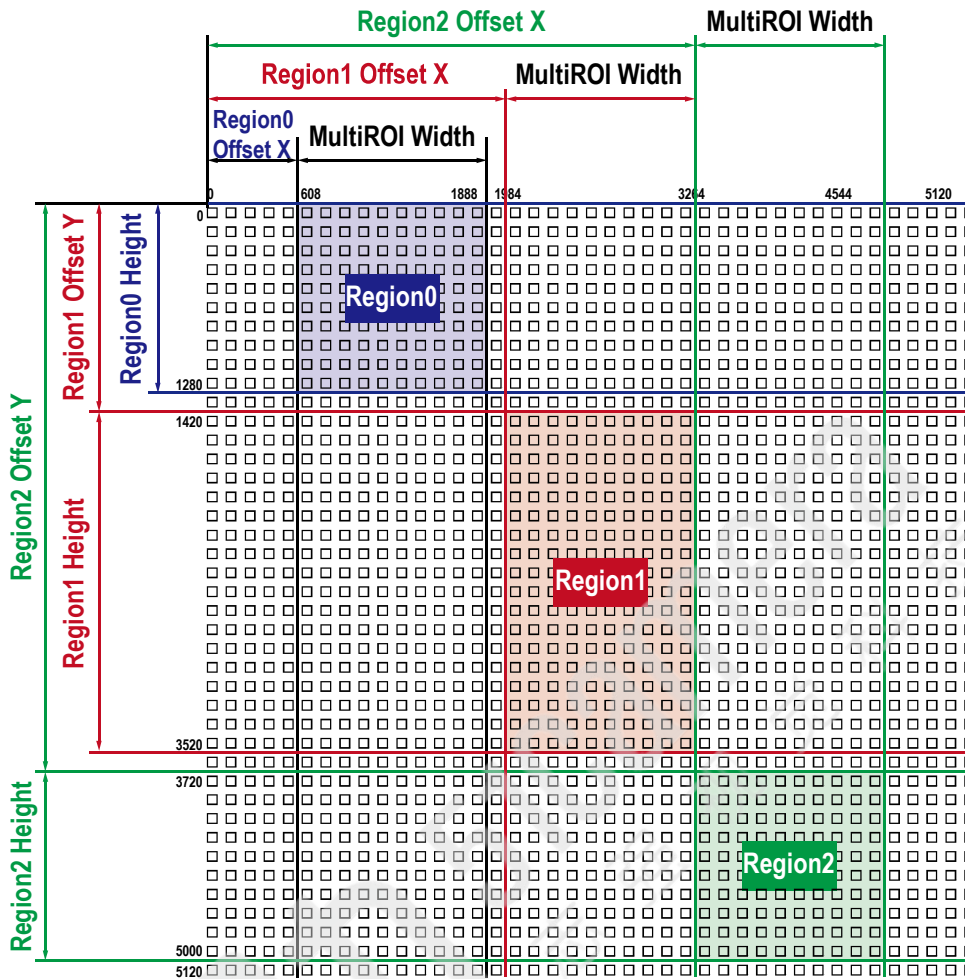

Figure 5-3 Multi-ROI (Sample)

When setting the Multi-ROI mode on the VPS-245MX2 camera, keep the following considerations in mind:

- The sum of the Multi-ROI Offset X value plus the Multi-ROI Width value must not exceed the Width value of the camera's sensor.
- The sum of the Multi-ROI Offset Y value plus the Multi-ROI Height value must not exceed the Height value of the camera's sensor.
- The Multi-ROI Offset X and Multi-ROI Width value must be a multiple of 32.
- The Multi-ROI Offset Y and Multi-ROI Height value must be a multiple of 8.
- The Multi-ROI Width values are equal, so the widths of the Region 0, Region 1, and Region 2 are the same in the figure above.
- You can save the Multi-ROI setting values as a User Set and then load the values to the camera when desired. For more information, refer to <5.24 User Set Control>.

### 5.4 CXP Link Configuration

The VPS-245MX2 camera must be connected to a CXP-12 Frame Grabber of CXP 2.0 interface. CoaXPress 2.0 interface allows you to connect a camera to a Frame Grabber supporting CXP 2.0 by using simple coax cabling and allows up to 12.5 Gbps data rate per cable. The VPS-245MX2 camera supports one master connection and up to three extension connections to configure a link. In compliance with the CoaXPress standard, the camera includes an automatic link detection mechanism (Plug and Play) to correctly detect the camera to CXP-12 Frame Grabber connections.

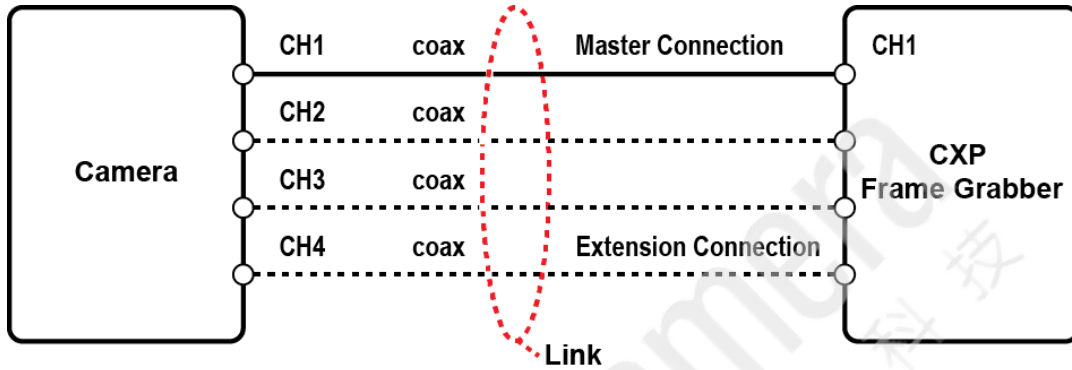

Figure 5-4 CXP Link Configuration

The XML parameters related to the link configuration between the camera and CXP-12 Frame Grabber are as follows:

XML Parameter	Value	Description
CoaXPress	CxpLinkConfiguration Preferred	Read Only <ul style="list-style-type: none"> <li>Displays bit rate and the number of connections to be set for the link configuration between the camera and Host (Frame Grabber) while discovering devices.</li> <li>Saves the current CxpLinkConfiguration values as the CxpLinkConfigurationPreferred value when you execute the User Set Save parameter.</li> </ul>
	CxpLinkConfiguration	CXP6_X1 CXP6_X2 CXP6_X4 CXP10_X1 CXP10_X2 CXP10_X4 CXP12_X1 CXP12_X2 CXP12_X4 Sets bit rate and the number of connections for the link configuration. e.g. CXP12_X4: Four connections running at a maximum of CXP12 speed (12.5 Gbps)

Table 5-6 XML Parameter for CXP Link Configuration

### 5.5 Pixel Format

The VPS-245MX2 camera internally processes image data in 12-bit format. You can use the **Pixel Format** parameter to set the pixel format of the image data (8-bit, 10-bit, or 12-bit). For example, if the camera is configured to use 10-bit output, the lower 2 bits of the original data will be discarded.

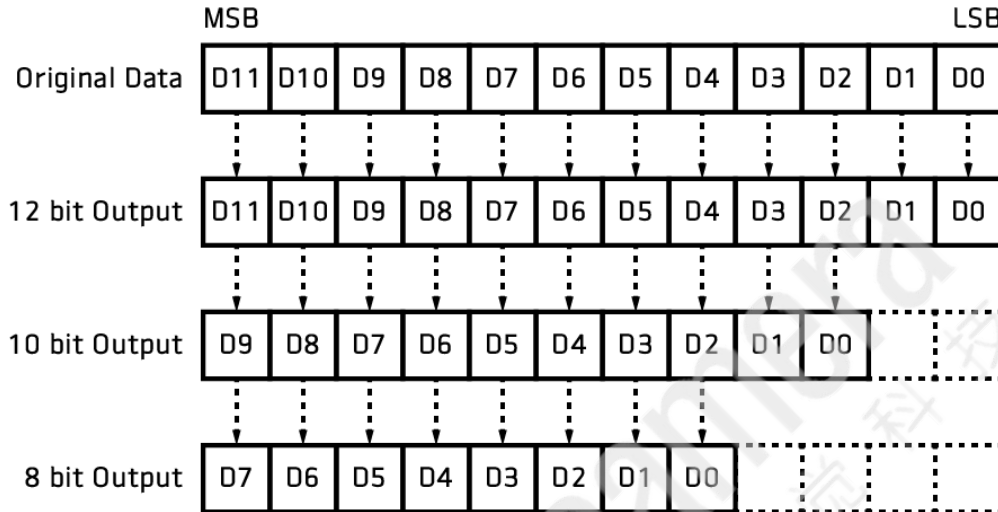

Figure 5-5 CXP Link Configuration

The XML parameter for Pixel Format is as follows:

XML Parameter		Description
ImageFormatControl	PixelFormat	Sets the pixel format supported by the device.

Table 5-7 XML Parameter for Pixel Format

The available pixel formats on the monochrome and color cameras are as follows:

Mono Sensor	Color Sensor
Mono 8	Mono 8
Mono 10	Mono 10
Mono 12	Mono 12
Mono 14	Mono 14
Mono 16	Mono 16
	Bayer RG 8
	Bayer RG 10
	Bayer RG 12
	Bayer RG 14
	Bayer RG 16

Table 5-8 Pixel Format Values

### 5.6 Data ROI (Color Only)

The Balance White Auto feature provided by the color camera uses the pixel data from a Data Region of Interest (ROI) to adjust the related parameters. The XML parameters related to Data ROI are as follows:

XML Parameter	Value	Description
DataRoiControl	DataRoiSelector	BalanceWhiteAuto Selects a Data ROI used for Balance White Auto. Only available on the color camera
	DataRoiOffsetX	- X coordinate of start point Data ROI
	DataRoiOffsetY	- Y coordinate of start point Data ROI
	DataRoiWidth	- Width of Data ROI
	DataRoiHeight	- Height of Data ROI

Table 5-9 XML Parameter for Data ROI

When both image ROI and data ROI are enabled, only the pixels in the overlapping region between the defined image ROI and data ROI are considered valid. The valid region is illustrated in the figure below.

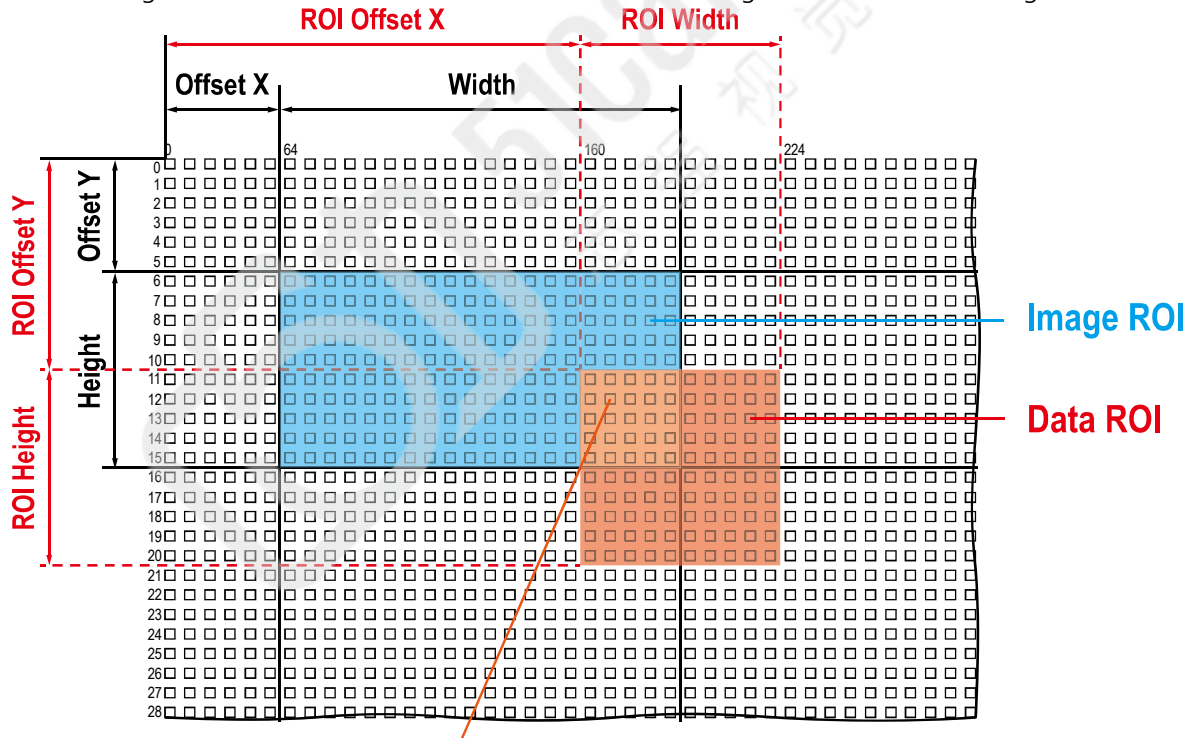

Effective Data ROI

Figure 5-6 Effective Data ROI(Sample)

## 5.7 White Balance (Color Only)

The color camera includes the white balance capability to adjust the color balance of the images transmitted from the camera. With the white balancing scheme used on the VPS-245MX2 camera, the Red, Green and Blue intensities can be adjusted individually. You can set the intensity of each color by using the Balance Ratio parameter. The Balance Ratio value can range from 1.0 to 4.0. If the Balance Ratio parameter is set to 1.0 for a color, the intensity of the color will be unaffected by the white balance mechanism. If the Balance Ratio parameter is set to greater than 1.0, the intensity of the color will be proportionally increased to the ratio. For example, if the Balance Ratio is set to 1.5, the intensity of that color will be increased by 50%

The XML parameters for White Balance are as follows:

XML Parameter		Value	Description
AnalogControl	BalanceRatioSelector	Red	A Balance Ratio value will be applied to red pixels.
		Green	A Balance Ratio value will be applied to green pixels.
		Blue	A Balance Ratio value will be applied to blue pixels.
	BalanceRatio	x1.0 to x4.0	Adjusts the ratio of the selected color.

**Table 5-10 XML Parameter for White Balance**

### 5.7.1 Balance White Auto

The Balance White Auto feature is implemented on the color camera. It will control the white balance of the image acquired from the color camera according to the GreyWorld algorithm. Before using the Balance White Auto feature, you need to set the Data ROI for Balance White Auto. If you do not set the related Data ROI, the pixel data from the Image ROI will be used to control the white balance. As soon as the Balance White Auto parameter is set to Once, the Balance Ratio values for Red and Blue will be automatically adjusted to adjust the white balance by referring to Green.

The XML parameter for Balance White Auto is as follows:

XML Parameter		Value	Description
AnalogControl	BalanceWhiteAuto	Off	Balance White Auto Off
		Once	White Balance is adjusted once and then Off.

**Table 5-11 XML Parameter for Balance White Auto**

## 5.8 Gain and Black Level

Increasing the Gain parameter increases all pixel values of the image. This results in a higher grey value output from the camera for a given amount of output from the image sensor.

- 1 Using Gain Selector parameters, select a type of Gain Control: Analog All and Digital All.
- 2 Input the desired value of Gain parameters.

By adjusting Black Level parameters, the pixel values output by the camera can be offset by the configured value.

- 1 Using Black Level Selector parameters, select a type of Black Level Control to Digital All.
- 2 Set the Black Level parameter to the desired value. The available setting range varies depending on the Pixel Format settings.

The XML parameters related to Gain and Black Level are as follows:

XML Parameter	Value	Description	
AnalogControl	GainSelector	Analog All	Applies the Gain value to all analog channels.
		Digital All	Applies the Gain value to all digital channels.
	Gain	1.0× to 16.0×	Sets an analog gain value.
		1.0× to 32.0×	Sets a digital gain value.
	BlackLevelSelector	DigitalAll	Applies the Black Level value to all digital channels.
BlackLevel	0 to 255.9375 at 12 bit 0 to 4095 at 16 bit	Sets a black level value.	

**Table 5-12 XML Parameter for Gain**

## 5.9 Defective Pixel Correction

A defective pixel in the CMOS sensor may not respond properly to light, resulting in degraded image quality. To resolve this issue, Defect Pixel Correction is performed. The defect pixel information used for each camera is input during the shipping stage. To add defective pixel information, input the new coordinates of the defective pixel into the camera. For more information, refer to <7.2 Field Upgrade>.

### 5.9.1 Correction Method

The correction value for a defective pixel is calculated based on the valid pixel values adjacent to it on the same line.

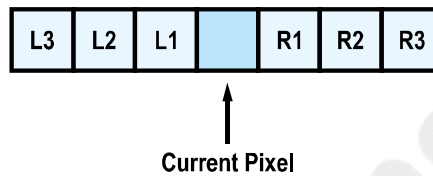

Figure 5-7 The Position of the Defective Pixel for Correction

When a current pixel is a defective pixel that needs correction as shown in the above image, the correction value of the current pixel is calculated depending on whether the surrounding pixels are defective.

Surrounding Pixels	Correction Value of Current Pixel
None	$(L1 + R1) / 2$
L1	R1
R1	L1
L1, R1	$(L2 + R2) / 2$
L1, R1, R2	L2
L2, L1, R1	R2
L2, L1, R1, R2	$(L3 + R3) / 2$
L2, L1, R1, R2, R3	L3
L3, L2, L1, R1, R2	R3

Table 5-13 Correction Values of Defective Pixel

## 5.10 Flat Field Correction

Flat Field Correction improves the image uniformity when the acquired image is uneven due to lighting issue and external conditions. The Flat Field Correction process can be summarized by the following equation.

$$IC = IR / IF$$

IC: Level value of corrected image  
IR: Level value of original image  
IF: Level value of Flat Field data

In actual use conditions, generate a Flat Field correction data and then save the data into the non-volatile memory of the camera by following the procedure below:

- 1 Execute the Flat Field Data Generate parameters.
- 2 Once an image is acquired, generate reduced Flat Field correction data.
- 3 Using the Flat Field Data Selector parameters, select the location to save the generated Flat Field correction data.
- 4 Save the Flat Field data to non-volatile memory by using the Flat Field Data Save parameters. The reduced Flat Field data is enlarged using bilinear interpolation, as shown in <Figure 5-11 Bilinear Interpolated Magnification>, before being applied for correction. To disregard the generated Flat Field correction data and load the existing Flat Field correction data, execute the Flat Field Data Load parameter before executing the Flat Field Data Save parameter.
- 5 Activate the Flat Field Correction parameters to apply the Flat Field data to the camera.



- It is recommended to enable the Defective Pixel Correction before generating the Flat Field data.
- Before executing the Flat Field Data Generate parameters, camera setting should be as follows:
  - OffsetX, Y: 0
  - Width and Height: Maximum values
- Execute the Acquisition Start command first to acquire an image and set the camera to Free-Run mode or supply the trigger signal to camera.

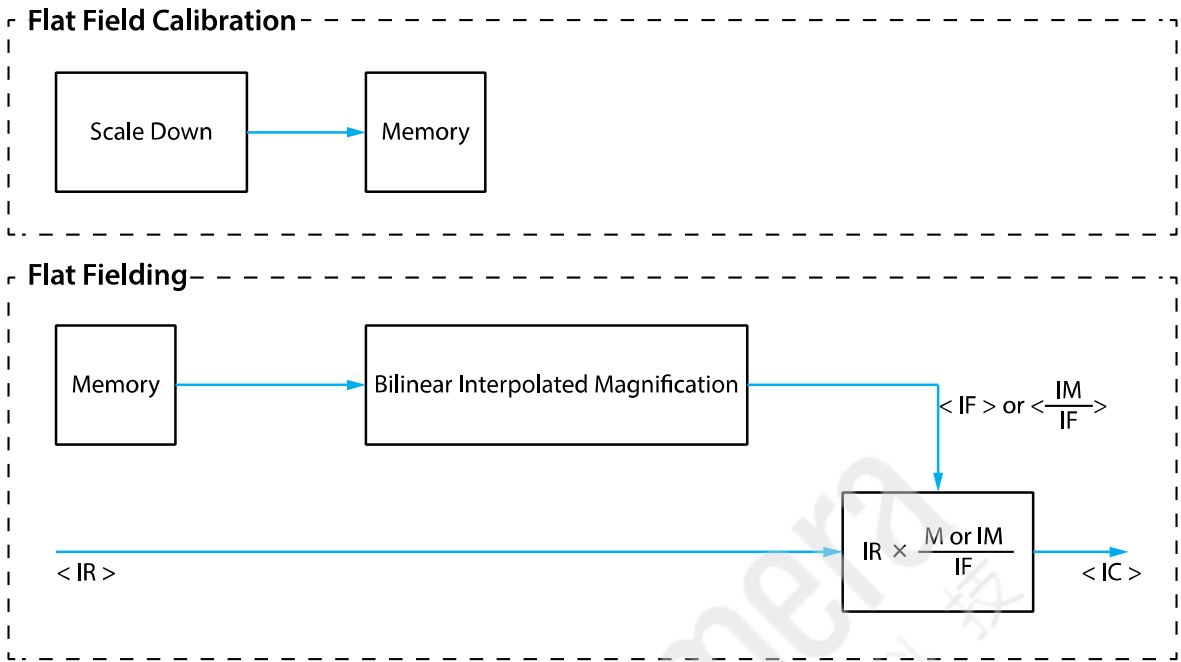

Figure 5-8 Generation and Application of Flat Field Data

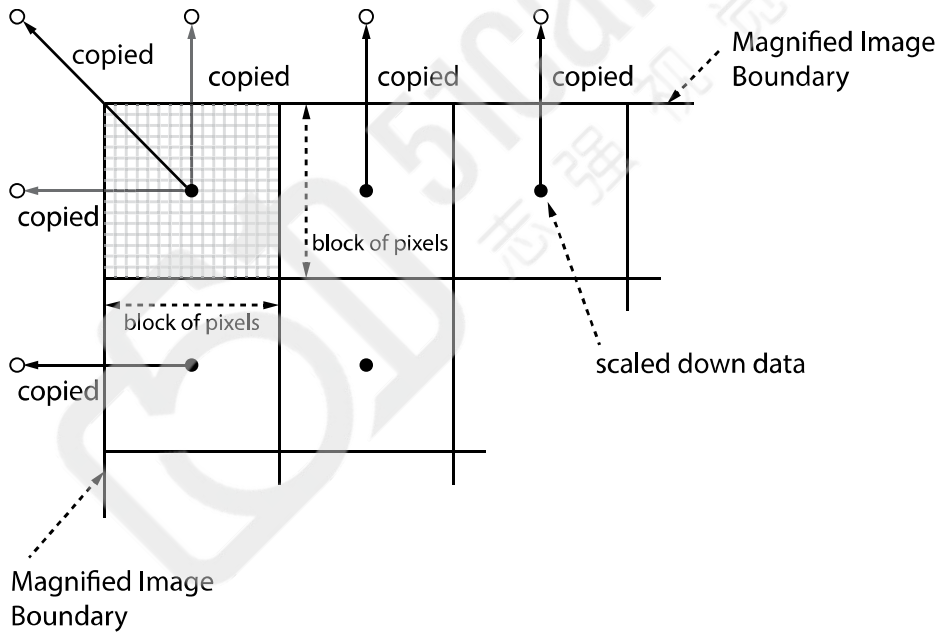

Figure 5-9 Bilinear Interpolated Magnification

The XML parameters related to Flat Field Correction are as follows:

XML Parameters	Value	Description	
FlatFieldControl	FlatFieldCorrection	Off	Deactivates Flat Field Correction.
		On	Activates Flat Field Correction.
	FlatFieldDataSelector	Space0 to Space6	Selects the area to generate, save, or retrieve the Flat Field data. Space0 to Space6: User-defined area
	FlatFieldDataGenerate	-	Generates the Flat Field data
	FlatFieldDataSave	-	Saves the generated Flat Field correction data to the non-volatile memory. By default, data created using FlatFieldDataGenerate is stored in volatile memory. To use the data persistently, be sure to save it to non-volatile memory and reboot the camera.
	FlatFieldDataLoad	-	Loads the Flat Field data stored in non-volatile memory to volatile memory.
FlatFieldDataDefault	Space 0 to 6	Sets the area to load FFC data at boot.	

Table 5-14 XML Parameter for Flat Field Correction

### 5.10.1 Flat Field Data Selector

As mentioned above, the generated Flat Field correction data are stored in the camera's volatile memory and the data are lost if the camera is reset or powered off. To use the generated Flat Field correction data after the camera is powered on or reset, you need to save them in the camera's non-volatile memory. The VPS-245MX2 camera provides thirty-two reserved locations in the camera's non-volatile memory available for saving and loading the Flat Field correction data. You can use the Flat Field Data Selector parameter to select a location as desired.

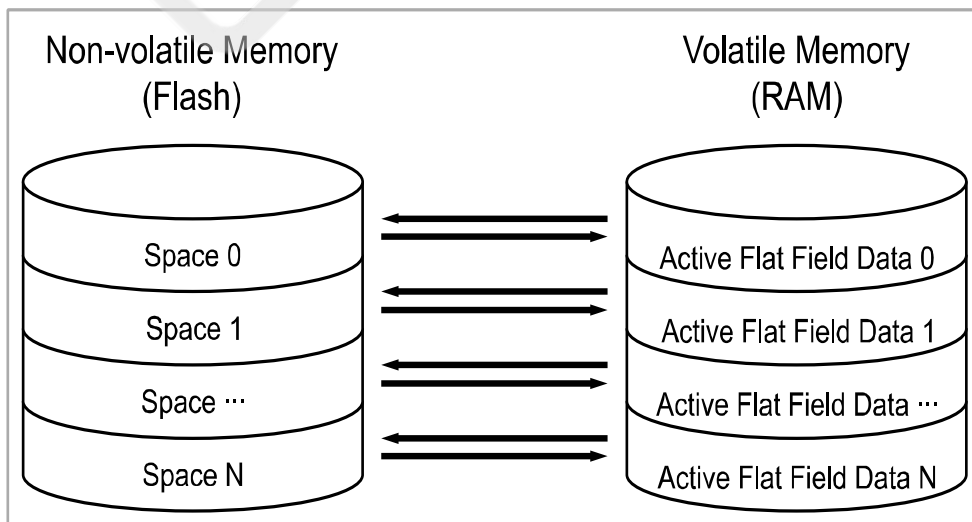

Figure 5-10 Flat Field Data Selector

### How to Save Flat Field Data

To save the currently-activated Flat Field data to the selected area in the flash memory, follow the procedure below:

- 1 Use the Flat Field Data Selector parameter to specify a location to save the active Flat Field data.  
Execute the Flat Field Data Save parameter to save the active Flat Field data to the selected location.

### How to Load the Flat Field Correction Data

If the Flat Field correction data has been saved to the camera's non-volatile memory, it can be loaded into the active Flat Field correction data area of the camera.

- 1 Use the Flat Field Data Selector parameter to specify a reserved location whose Flat Field correction data will be loaded into the camera's active Flat Field data location.
- 2 Execute the Flat Field Data Load parameter to load the selected Flat Field correction data into the active Flat Field data location.



## 5.11 Timestamp

The VPS-245MX2 camera provides a Timestamp feature.

The XML parameter for Timestamp is as follows:

XML Parameter		Description
DeviceControl	Timestamp	Indicates the current Timestamp value of the connected device.
	TimestampIncrement	Indicates the increment of Timestamp.
	TimestampReset	Changes the current Timestamp value into 0 and restarts counting.
	TimestampResetValue	Designates time to reset Timestamp as 0, by the form in the numeric value.
	TimestampLatch	Latches the current value of Timestamp.
	TimestampLatchValue	Indicates prior value before resetting the Timestamp value.

**Table 5-15 XML Parameters for Timestamp**

## 5.12 Event Control

The VPS-245MX2 camera provides an Event Control feature. Using the TestEventGenerate parameters, it generates an event and transmits a related event message to the PC whenever a specific situation has occurred.

The XML parameters for Event Control are as follows:

XML Parameter	Value	Description	
EventControl	EventSelector	Test	Transfers the Test event generated from the execution of the TestEventGenerate parameter.
	EventNotification	On	Enables the selected event notification.
Off		Disables the selected event notification.	
TestControl	TestPendingAck	-	Sets time to wait before writing the device's pending acknowledge feature.
	TestEventGenerate	-	Generates a Test event.

**Table 5-16 XML Parameters for Event Control**

## 5.13 Digital I/O Control

The Control I/O receptacle of the camera can be operated in various modes.

The XML parameters related to Digital I/O Control are as follows:

XML Parameter	Value	Description	
DigitalIOControl	LineSelector	Line0	Selects the number 1 pin of the camera's Control I/O receptacle as an input line. <ul style="list-style-type: none"> <li>• <b>LineInverter</b> and <b>LineSource</b> are unavailable when set to Line0.</li> </ul>
		Line1	Selects the number 4 pin of the camera's Control I/O receptacle as an output line.
	LineMode	Input	Available only when the LineSelector is set to Line0
		Output	Available only when the LineSelector is set to Line1
	LineInverter	FALSE	Disables inversion on the output signal of the line.
		TRUE	Enables inversion on the output signal of the line.
	LineSource	Off	Disables the line output.
		FrameActive	Outputs a pulse during the readout period of one frame.
		LineActive	Outputs a pulse during the readout period of one line.
		ExposureActive	Outputs a pulse corresponding to the current exposure time.
		UserOutput0	Outputs a pulse according to the UserOutputValue setting.
		Timer0Active	Outputs a pulse corresponding to the user-set timer signal.
		Counter0Active	Outputs a pulse corresponding to the counter.
		Strobe	Outputs strobe as pulse signals. It goes high when the exposure time for the bottom line of pixels begins and goes low when the exposure time for the top line of pixels ends.
	StrobeMode	Narrow	Outputs a narrower waveform for the strobe. <ul style="list-style-type: none"> <li>▪ The narrow signal is only available when the exposure time is longer than the readout time.</li> <li>▪ The light has a narrow output area and is evenly distributed.</li> </ul>
		Wide	Outputs a wider waveform for the strobe. The light has a wide output area and is unevenly distributed.

	Debounce Time	0 to 1,000,000	Sets a Debounce Time in microseconds (Default: 0.5 $\mu$ s). <ul style="list-style-type: none"> <li>Available only when the LineSelector is set to Line0.</li> </ul>
	UserOutput Selector	UserOutput0	Outputs pulse signals set by User Output Value.
	UserOutput Value	FALSE	Sets the bit state of the line to Low.
		TRUE	Sets the bit state of the line to High.

**Table 5-17 XML Parameters for Digital I/O Control**

When you set the Line Source to **UserOutput0**, you can use the user setting values as output signals.

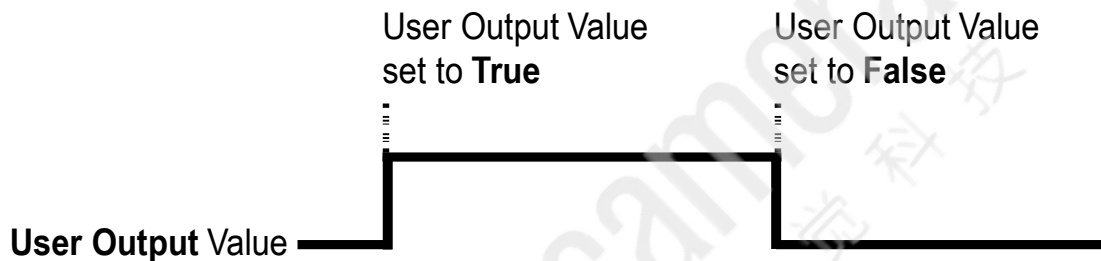

**Figure 5-11 User Output**

The camera provides the Exposure Active output signal. As shown in the following figure, the Exposure Active signal rises when the exposure time begins and falls when the exposure time ends. This signal can be used to trigger a flash and is especially useful in environments where either the camera or the subject is moving. Generally, the camera should remain stationary during the exposure process. By monitoring the Exposure Active signal, you can determine when exposure is occurring and when the camera must not be moved.

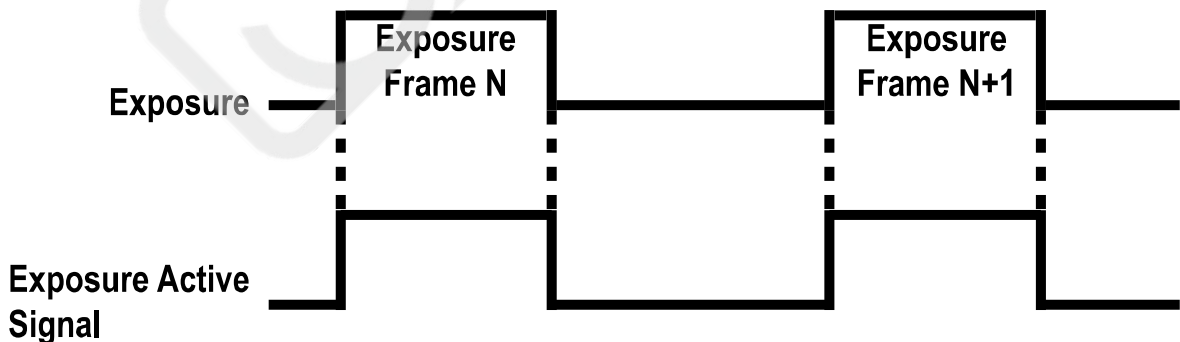

**Figure 5-12 Exposure Active Signal**

### 5.13.2 Strobe

The VPS-245MX2 camera provides two types of the Strobe signal: **Wide Output** and **Narrow Output**. The Wide Strobe signal goes high when the exposure time for the top line of pixels begins and goes low when the exposure time for the bottom line of pixels ends. The Narrow Strobe signal goes high when the exposure time for the bottom line of pixels begins and goes low when the exposure time for the top line of pixels ends. Then Narrow Strobe signal is only available when the exposure time is longer than the readout time and is useful when you are operating the camera under the flash lighting conditions.

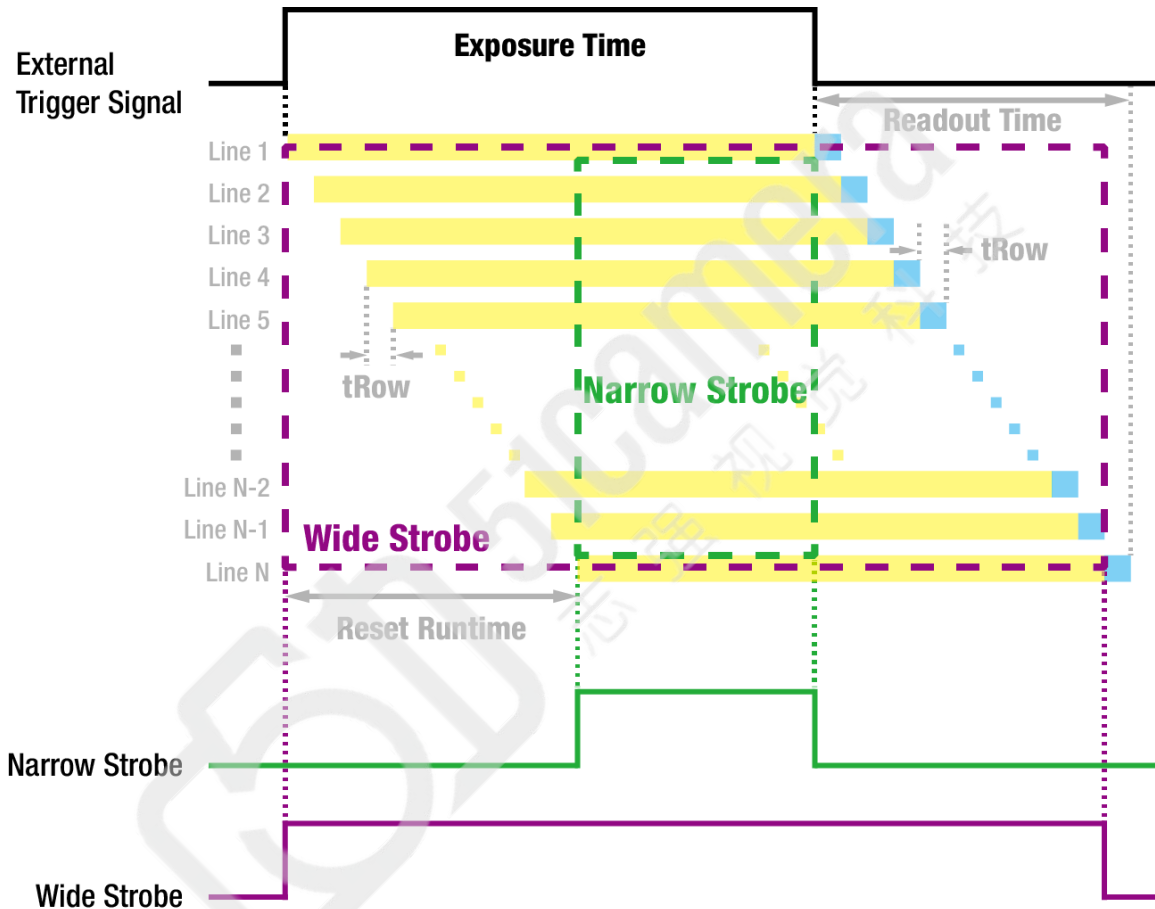

Figure 5-13 Strobe Signal

### 5.13.3 Debounce

A Debounce feature allows to supply only valid signals to the camera by discriminating between valid and invalid input signals. The Debounce Time parameter specifies the minimum time that an input signal must remain High or Low in order to be considered as a valid input signal. When you use the Debounce feature, be aware that there is a delay between the point where the valid input signal arrives and the point where the signal becomes effective. The duration of the delay is determined by the Debounce Time parameter setting value.

When you set the Debounce Time parameter, High and Low signals shorter than the setting value are considered invalid and ignored as shown in the figure below:

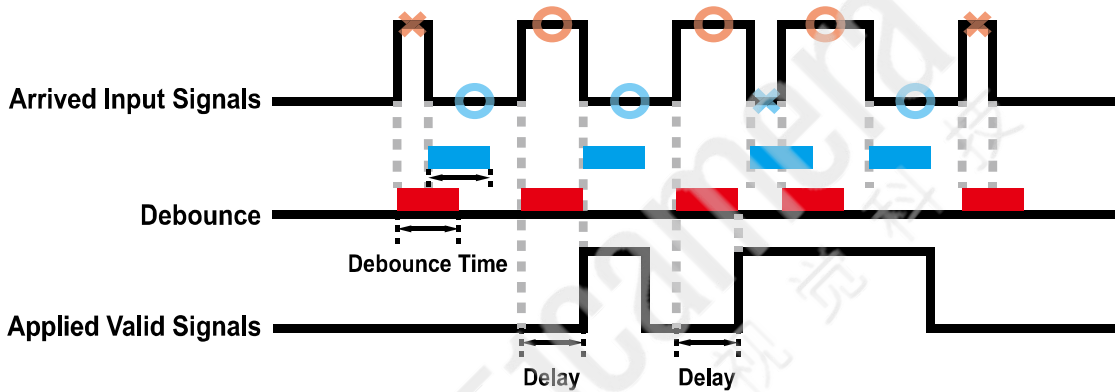

Figure 5-14 Debounce

The XML parameter for Debounce Time is as follows:

XML Parameter		Value	Description
DigitalIOControl	Debounce Time	0 to 1,000,000 $\mu$ s	Sets a Debounce Time in microseconds (Default: 0.5 $\mu$ s).

Table 5-18 XML Parameter for Debounce Time

## 5.14 Timer Control

When setting Line Source to Timer0Active, the camera can provide output signals by using the Timer. The VPS-245MX2 camera can use Frame Active, Exposure Active events, or external trigger signals as source signals for the timer.

The XML parameters for Timer are as follows:

XML Parameter	Value	Description	
CounterAnd TimerControl	TimeSelector	Timer0	Selects a Timer to configure.
	TimerDuration	1 to 85,899,344 $\mu$ s	Sets the duration of the Timer output signal to be used when Timer Trigger Activation is set to Rising/Falling Edge.
	TimerDelay	0 to 85,899,344 $\mu$ s	Sets the delay time to be applied before starting the Timer.
	TimerReset	-	Resets the Timer and starts it again.
	TimerValue	-	Displays the current value of the selected Timer.
	TimerStatus	TimerIdle	Indicates that the Timer is in ready.
		TimerTriggerWait	Indicates that the Timer is waiting for trigger signals.
		TimerActive	Indicates that the Timer is activated.
		TimerCompleted	Indicates that the Timer is completed.
	TimerTriggerSource	Off	Disables the Timer trigger.
		ExposureActive	Sets the Timer to use the current exposure time as the source signal.
		FrameActive	Sets the Timer to use the frame readout time as the source signal.
		LinkTrigger0	Sets the Timer to use the link trigger readout time as the source signal.
		Line 0	Sets the Timer to use the external trigger signal as the source signal.
		Counter0Trigger	Sets the Timer to use the Counter0Trigger signal as the source signal
	TimerTriggerActivation	RisingEdge	Specifies that a rising edge of the selected trigger signal will act as the Timer trigger.
		FallingEdge	Specify the rising and falling edges of the selected trigger signal to act as the Time trigger.

		AnyEdge	Specifies the rising and falling edges of the selected trigger signal to act as triggers for the timer output signal.
		LevelHigh	Specifies that the Timer output signal will be valid as long as the selected trigger signal is High.
		LevelLow	Specifies that the Timer output signal will be valid as long as the selected trigger signal is Low.

**Table 5-19 XML Parameters for Time Control**

When the Timer Trigger Source is set to Exposure Active and the Timer Trigger Activation is set to Level High, the timer operates in the following order:

- 1 When the source signals set by the Timer Trigger Source parameter are applied, the Timer will start operations.
- 2 The delay time set by the Timer Delay parameter starts and then expires.
- 3 When the delay time expires, the timer signal goes high for the duration of the High period of the source signal.

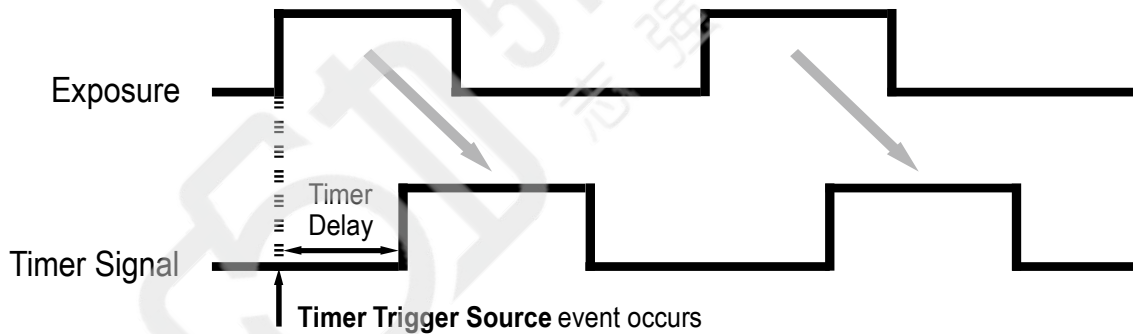

\* Timer Trigger Activation is set to Level High.

**Figure 5-15 Timer Signal**

## 5.15 Cooling Control

A fan is installed on the rear panel of the camera to radiate heat. You can set the fan to turn on or off. You can also set the fan to turn on when a specified internal temperature is reached.

The XML parameters related to Cooling Control are as follows:

XML Parameter	Value	Description
CoolingControl	TargetTemperature	-10°C to 80°C Turns on the fan automatically when the temperature set in this parameter.
	FanOperationMode	On/Off Turns on/off the fan.
	FanSpeed	- Displays the current Fan RPM.

Table 5-20 XML Parameter for Cooling Control

## 5.16 Temperature Monitor

The camera has an embedded sensor chip to monitor the internal temperature.

The XML parameter for the device temperature is as follows:

XML Parameter	Value	Description	
DeviceControl	DeviceTemperatureSelector	Sensor	Sets a temperature measuring spot to the image sensor.
	DeviceTemperatureSelector	Mainboard	Sets a temperature measuring spot to the mainboard.
	DeviceTemperature	-	Displays device temperature in Celsius.

**Table 5-21 XML Parameter for Device Temperature**

## 5.17 Status LED

A LED is installed on the rear panel of the camera to inform the operation status of the camera.

Status LEDs indicating the camera status are as follows:

Status LED	Description
Steady Red	The camera is not initialized.
Slow Flashing Red	A CXP Link is not configured.
Fast Flashing Orange	The camera is checking a CXP Link configuration.
Steady Green	A CXP Link is configured.
Fast Flashing Green	The camera is transmitting image data.

**Table 5-22 Status LED**

## 5.18 Test Pattern

To check if a camera successfully operates, a user can set to output a test pattern generated internally, instead of outputting a test pattern from the image sensor. There are 4 types of test patterns: images with different values in horizontal direction (Grey Horizontal Ramp), images with different values in diagonal direction (Grey Diagonal Ramp), moving images with different values in diagonal direction (Grey Diagonal Ramp Moving) and images with different values in horizontal direction output from the image sensor (Sensor Specific).

The XML parameter for test patterns is as follows:

XML Parameter		Value	Description
ImageFormatControl	TestPattern	Off	Disables the Test Pattern feature.
		GreyHorizontalRamp	Sets to Grey Horizontal Ramp.
		GreyDiagonalRamp	Sets to Grey Diagonal Ramp.
		GreyDiagonalRampMoving	Sets to Grey Diagonal Ramp Moving.
		SensorSpecific0	Sets to the Test Pattern generated by the image sensor.

Table 5-23 XML Parameter for Test Pattern



Figure 5-16 Grey Horizontal Ramp

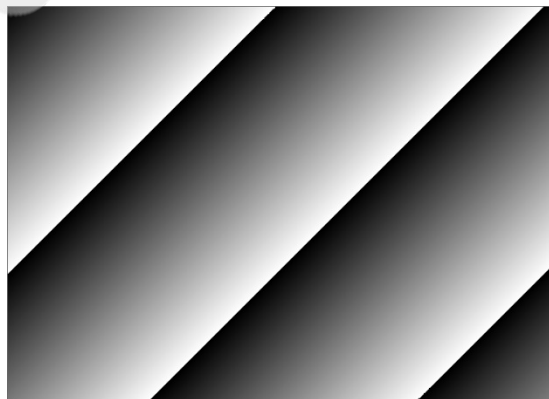

Figure 5-17 Grey Diagonal Ramp

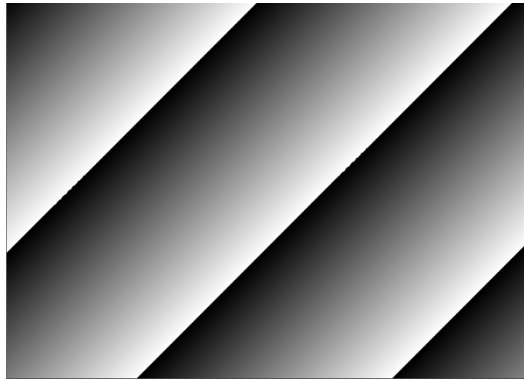

Figure 5-18 Grey Diagonal Ramp Moving

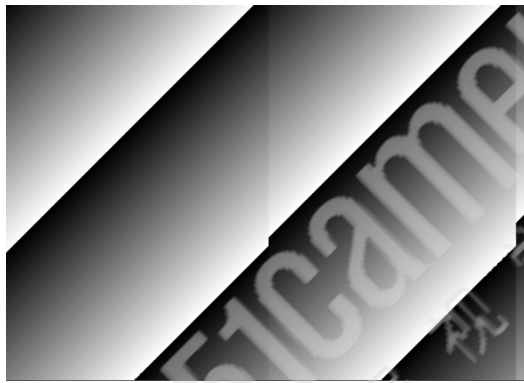

Figure 5-19 Sensor Specific



- Depending on the resolution, the area of the output test pattern varies, and the image may look different.

## 5.19 Reverse X

A user can horizontally reverse an image. It is available in almost all of the operation modes of the camera, except for the Test Image mode.

The XML parameter for Reverse X is as follows:

XML Parameter		Value	Description
ImageFormatControl	ReverseX	FALSE	Disables the Reverse X feature.
		TRUE	Flips images horizontally.

Table 5-24 XML Parameter for Reverse X



Figure 5-20 Image before applying Reverse X



Figure 5-21 Image after applying Reverse X

## 5.20 Device Link Throughput Limit

Using a Device Link Throughput Limit feature, a user can limit the maximum available bandwidth when transmitting data to a computer.

The XML parameter for Device Link Throughput Limit is as follows:

XML Parameter		Description
DeviceControl	DeviceLinkThroughputLimit	Limits the maximum available bandwidth (bps).

**Table 5-25 XML Parameter for Device Link Throughput Limit**



- To ensure good image quality, we recommend that you set the Device Link Throughput Limit parameter to the maximum value. Otherwise, the image quality can decrease. The maximum value of VPS-245MX2 is 8000.

## 5.21 Device User ID

You can input user-defined information up to 16 bytes .

The XML parameter related to Device User ID is as follows:

XML Parameter		Description
DeviceControl	DeviceUserID	Inputs user-defined information (16 bytes).

**Table 5-26 XML Parameter for Device User ID**



## 5.22 Device Reset

Resets the camera physically to power off and on.

The XML parameter related to Device Reset is as follows

XML Parameter		Description
DeviceControl	DeviceReset	Resets the camera physically.

Table 5-27 XML Parameter for Device Reset



## 5.23 Field Upgrade

A feature that upgrades the firmware and FPGA logic via Camera Link interface without requiring disassembly of the camera on site is provided. Refer to <7 Appendix> for more information.



### 5.24 User Set Control

A user can save or load the camera setting to the internal flash area. 2 save areas and 3 load areas are available.

The XML parameter for User Set Control is as follows:

XML Parameter	Value	Description	
UserSetControl	UserSetSelector	Default	Selects the Factory Default settings.
		UserSet1	Selects the UserSet1 settings.
		UserSet2	Selects the UserSet2 settings.
	UserSetLoad	-	Loads the User Set specified by User Set Selector to the camera.
	UserSetSave	-	Saves the current settings to the User Set specified by User Set Selector. The Default is a Factory Default Settings and allowed to load only.
	UserSetDefault	Default	Applies the Factory Default settings when reset.
		UserSet1	Applies the UserSet1 when reset.
		UserSet2	Applies the UserSet2 when reset.

Table 5-28 XML Parameter for User Set Control

Camera settings saved in the Default area can be loaded into the camera’s workspace but cannot be modified. To remove the configured values from the workspace, reboot or reset the camera. If you want to retain the current workspace settings after a reset, save them to one of the user areas.

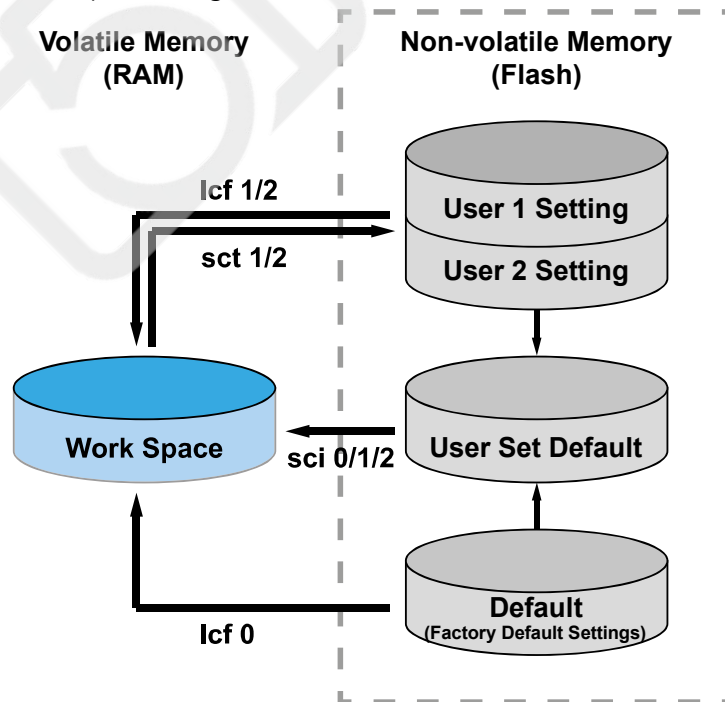

Figure 5-22 User Set Control

## 5.25 Sequence Control

Sequence Control applies different sets of parameter settings, called 'Sequencer Set', to a sequence of image acquisitions. As the camera acquires images, it applies one Sequencer Set after the other. This allows the camera to respond quickly to changing imaging requirements. For example, a user can apply a different exposure time to each shot by presetting a Sequencer Set. With a Sequencer Set configured, the camera automatically changes the exposure time with every shot.

With a User Set Control feature, the configured Sequencer Set can be saved to non-volatile memory of the camera. After turning the camera off and on or performing a reset, the Sequencer Set can be used according to the User Set Default settings. Each Sequencer Set is identified by an index number from 0 to 7, allowing up to 8 different Sequencer Sets to be configured.

XML Parameter	Value	Description	
Sequencer Control	SequencerMode	Off	Disables the Sequencer.
		On	Enables the Sequencer.
	Sequencer ConfigurationMode	Off	Disables the Sequencer Configuration Mode.
		On	Enables the Sequencer Configuration Mode.
	SequencerFeatureSelector	FlatFieldData Default	Applies the Flat Field data stored in the area configured in FlatFieldDataDefault to the selected Sequencer Set.
		GainDigitalAll	Applies the Gain value set in DigitalAll to the selected Sequencer Set.
		ExposureTime	Applies the ExposureTime value set to the selected Sequencer Set.
	SequencerFeatureEnable	Ture	Disables the feature selected in SequencerFeatureSelector and clears it from all Sequencer Sets.
		False	Enables the feature selected in SequencerFeatureSelector and applies it to all Sequencer Sets.
	SequencerSetSelector	0 to 7	Selects the Sequencer Set to configure.
	SequencerSetSave	-	Saves the current camera settings to the Sequencer Set selected in SequencerSetSelector.
	SequencerSetLoad	-	Selects the Sequencer Set selected in SequencerSetSelector and applies to the current camera settings.
	SequencerSetActive	-	Displays the index number (0 to 7) of the currently-active Sequencer Set.

SequencerSetStart	0 to 7	Indicates or sets the index number of the Sequencer Set that will operate as the initial default.
SequencerPathSelector	0 to 1	Selects the path of the currently configured or active Sequencer Set. The next Sequencer Set to be executed depends on the selected path. The index number (0–1) indicates the identifier of each path.
SequencerSetNext	0 to 7	Specifies which Sequencer Set to execute next when the path selected in SequencerPathSelector is Path 0 or Path 1.
SequencerTriggerSource	Off	Disables Sequencer Trigger.
SequencerTrigger Activation	FallingEdge	Uses FallingEdge signals as the Sequencer Trigger.

**Table 5-29 XML Parameter for Sequence Control**



- To apply Sequencer Set, turn on the Trigger Mode parameters.

### Use Case - Applying Four Different Sets of Flat Field Correction Data, Gain and Exposure Time Settings to Sequencer Sets

For example, assume that four different sets of Flat Field correction data, Gain and Exposure settings optimized for White, Green, Red and Blue pixels are applied to four different Sequencer Sets to inspect LCD panels.

- 1 Set the SequencerMode parameter to Off.
- 2 Select a feature to be applied to Sequencer Sets by using the SequencerFeatureSelector parameter. Before starting SequencerConfigurationMode, specify which feature to apply to Sequencer Set.
  - Set the SequencerFeatureSelector parameter to FlatFieldDataSelector, and then set the SequencerFeatureEnable parameter to On.
  - Set the SequencerFeatureSelector parameter to GainDigitalAll, and then set the SequencerFeatureEnable parameter to On.
  - Set the SequencerFeatureSelector parameter to ExposureTime, and then set the SequencerFeature Enable parameter to On.
- 3 Set the SequencerConfigurationMode parameter to On.
- 4 Set the SequencerSet 0 first.
  - SequencerSetSelector parameter: 0
  - FlatFieldDataSelector parameter in FlatFieldControl: Space0
  - The Gain parameter of DigitalALL in the AnalogControl category: 1
  - The ExposureTime parameter in AcquisitionControl: 10000

- SequencerSetNext parameter: 1
  - SequencerPathSelector parameter: 0
  - SequencerTriggerSource parameter: FrameActive
  - SequencerTriggerActivation parameter: FallingEdge
  - SequencerPathSelector parameter: 1
  - SequencerTriggerSource parameter: Off
- 5 Using the following information, configure Sequencer Sets 1, 2, and 3 by following the same procedure as in step 4.

Order	Parameter	Sequencer Set 1	Sequencer Set 2	Sequencer Set 3
1	SequencerSetSelector	1	2	3
2	FlatFieldDataSelector	Space1	Space2	Space3
3	DigitalALL, Gain	2	3	4
4	ExposureTime	20000	30000	40000
5	SequencerSetNext	2	3	0
6	SequencerPathSelector	0	0	0
7	SequencerTriggerSource	FrameActive	FrameActive	FrameActive
8	SequencerTriggerActivation	FallingEdge	FallingEdge	FallingEdge
9	PathSelector	1	1	1
10	SequencerTriggerSource	Off	Off	Off

- 6 Set the SequencerConfigurationMode to Off and the SequencerMode parameter to On.

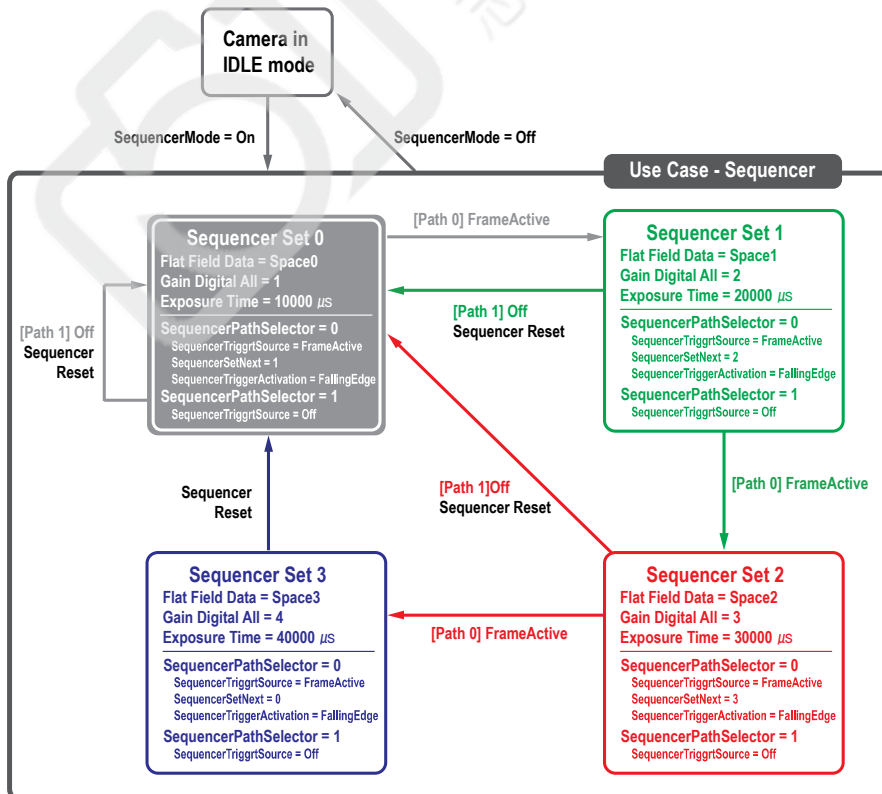

Figure 5-23 Sequencer Diagram (Use Case)



- When you set the Sequencer Configuration Mode parameter to On, the following features will be enabled for the application of Sequencer Sets by default.  
Flat Field Data Selector = Enabled, Space0  
Gain Digital All = Enabled, Gain = 1  
Exposure Time = Enabled, 10000
- You can save the user defined Sequencer Sets in the camera's non-volatile memory by using the User Set Control feature. For more information, refer to <5.24 User Set Control>.
- Executing the Sequencer Reset parameter allows to return to the Sequencer Set 0 status at any time while cycling through the Sequencer.



---

## 6. Troubleshooting

---

Troubleshooting

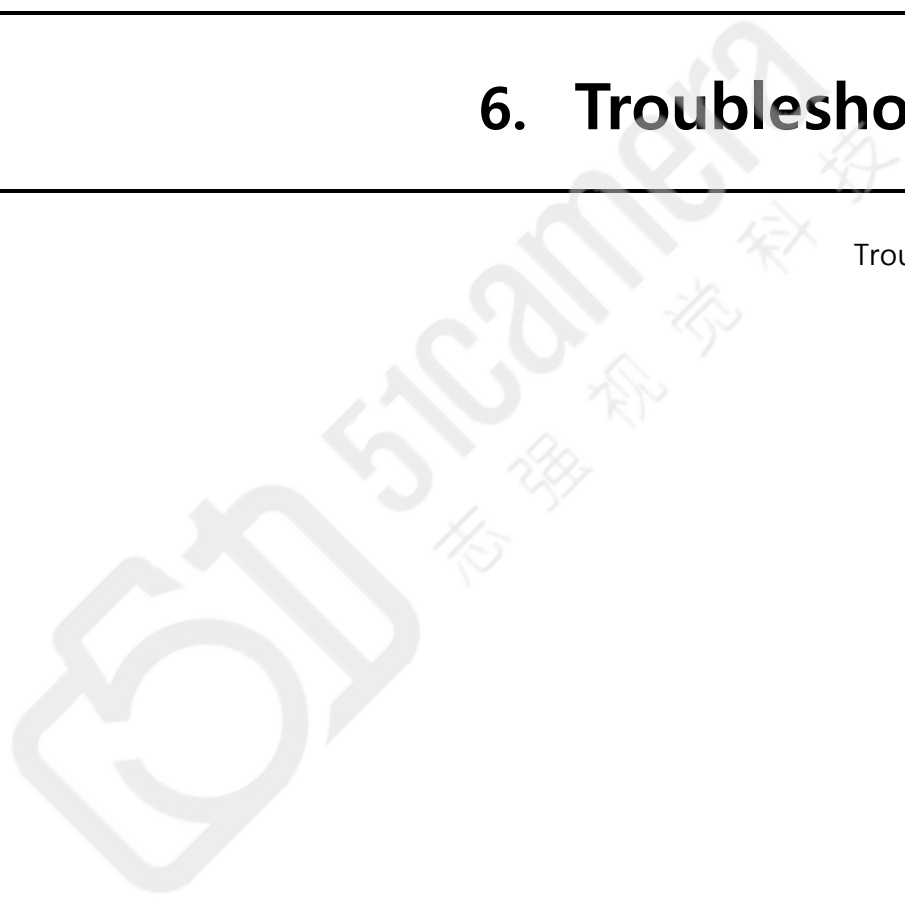

## 6.1 Troubleshooting

Check the below cases if the device malfunctions:

### When nothing is shown on the screen

- Check if the cable connections are properly made.
- Check if the power supply is functioning correctly.
- If using external trigger input mode, make sure the trigger is being correctly input.

### When the image is blurry

- Check if there is dust on the lens or glass.
- Verify that the lens focus is properly adjusted.

### When the image appears dark

- Check if the lens is obstructed.
- Ensure the Line Rate setting is appropriate.
- Check if the aperture is closed.
- Make sure the Digital Gain value is not set too low.

### When the camera is behaving abnormally and overheating

- Verify that the power connection is properly established.
- If smoke or abnormal heating occurs, stop using the camera immediately.

### When the trigger mode is not working properly

- For CXPin trigger mode, ensure the trigger setting is correctly configured in the CXP Frame Grabber.
- For external trigger mode, check if the cable connections are properly made.

### When communication quality is poor

- Ensure the Coax cable connection is properly established.
- Verify that the camera is correctly connected to the CXP Frame Grabber installed on the user's computer and that the settings are properly configured.

---

## 7. Appendix

---

Defective Pixel Map Download  
Field Upgrade

## 7.1 Defective Pixel Map Download

- 1 Create the Defective Pixel Map data in Excel as shown in the image on the left below, and save it as a CSV file (\*.csv). The image on the right shows how the file appears when opened in a text editor. Follow the rules below when creating the file:
  - Lines beginning with : or – are treated as comments.
  - Each row must list the horizontal coordinate value followed by the vertical coordinate value.
  - The order in which pixels are entered does not matter.

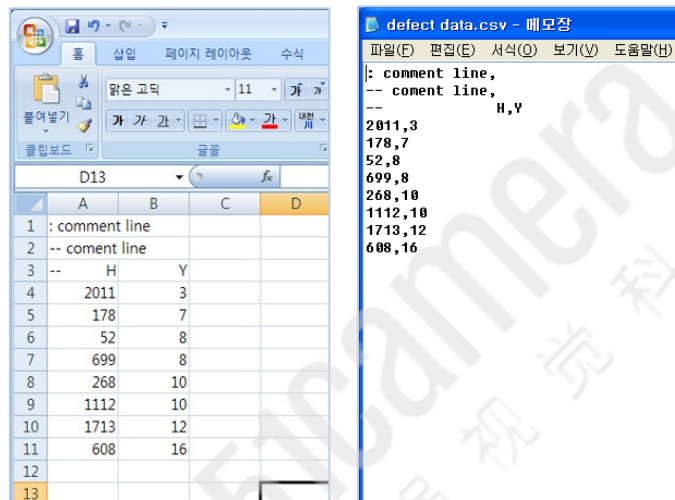

- 2 Execute Vieworks Imaging Solution 7.X and open the window below by clicking **Configure** button. In **Defect** tab, select the csv file to download from **File Path** and click the **Download** button.

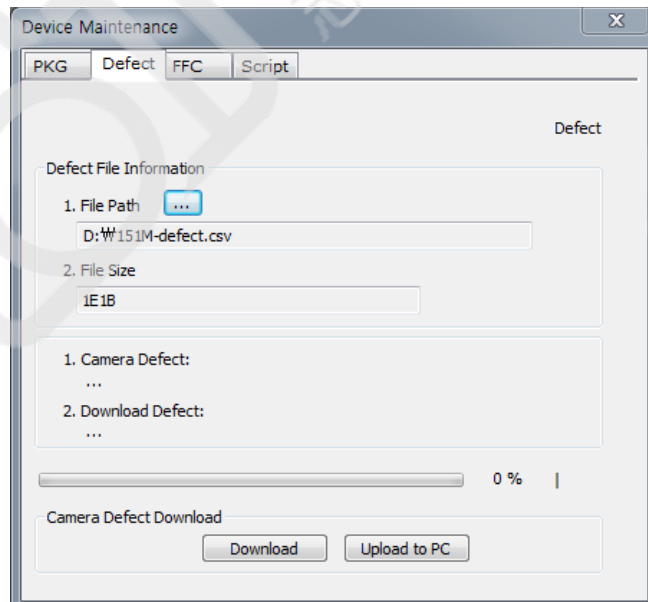

- 3 Once the download is complete, the saving process will begin. Do not disconnect the power during this process.

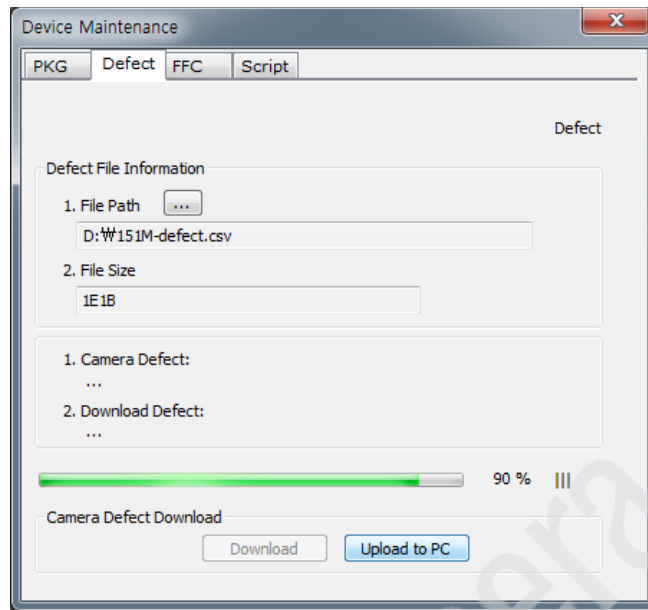

4 Click OK button to close the window.

## 7.2 Field Upgrade

To keep the MCU, FPGA, and XML updated to the latest version, follow the steps below:

### 7.2.1 MCU

- 1 Open Vieworks Imaging Solution 7.X and click the **Configuration** button.
- 2 In the MCU tab of the Device maintenance window, click the ... button next to the **File Path** to select the MCU Upgrade file. Then, click the **Download** button.

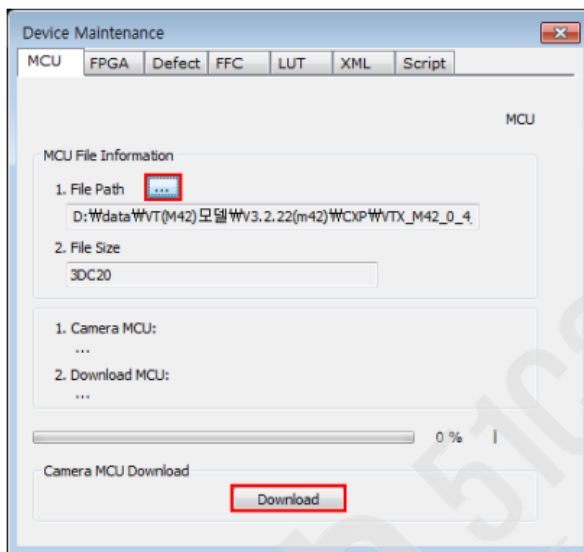

- 3 The download progress of the MCU upgrade file can be monitored as shown below:

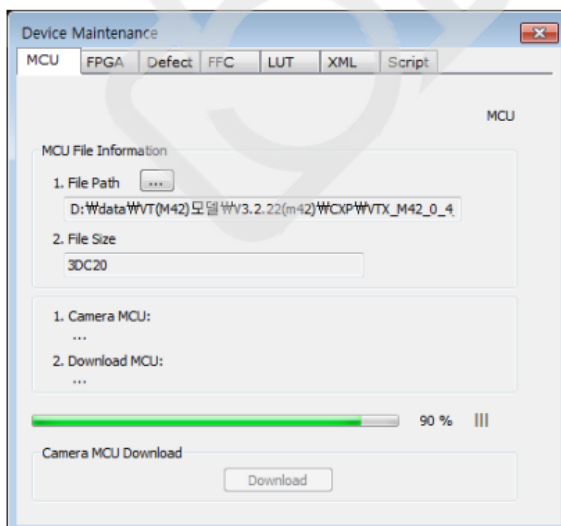

- 4 Once all processes are complete, turn off and on the camera. Check the version by reading the DeviceVersion parameter in the Device Control category.

## 7.2.2 FPGA

- 1 Open Vieworks Imaging Solution 7.X and click the **Configuration** button.
- 2 In the FPGA tab of the Device maintenance window, click the ... button next to the File Path to select the FPGA Upgrade file. Then, click the **Download** button.

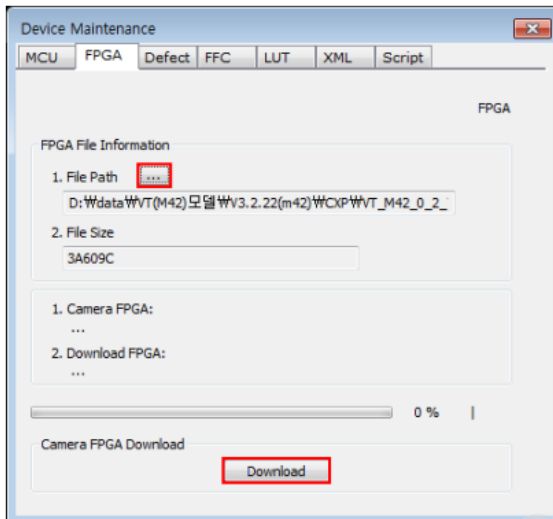

- 3 The process from now on is the same as the MCU upgrade process.

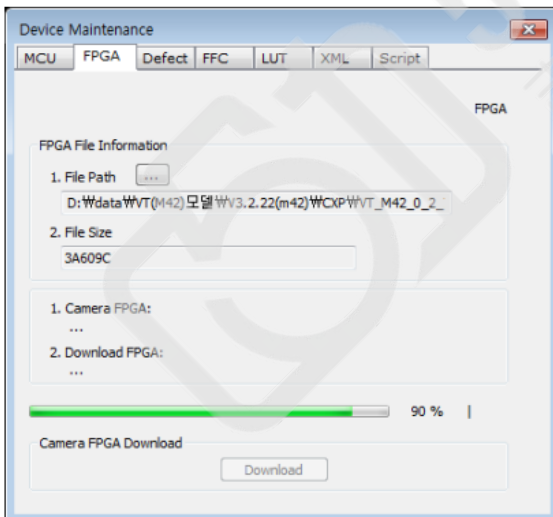

### 7.2.3 XML

- 1 Open Vieworks Imaging Solution 7.X and click the **Configuration** button.
- 2 In the XML tab of the Device maintenance window, click the ... button next to the File Path to select the XML Upgrade file. Then, click the **Download** button.

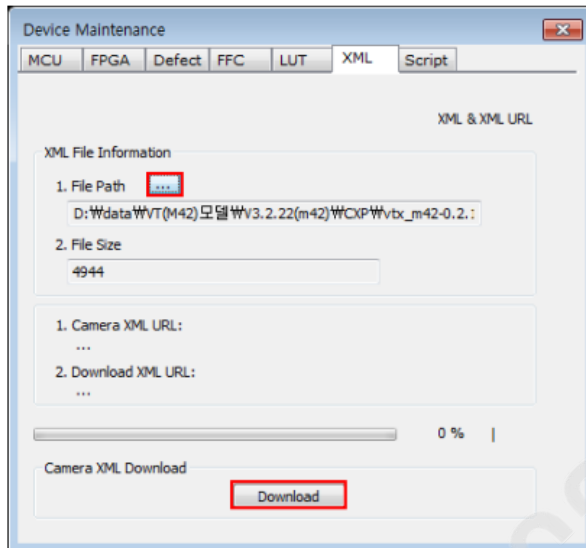

- 3 The process from now on is the same as the MCU upgrade process.

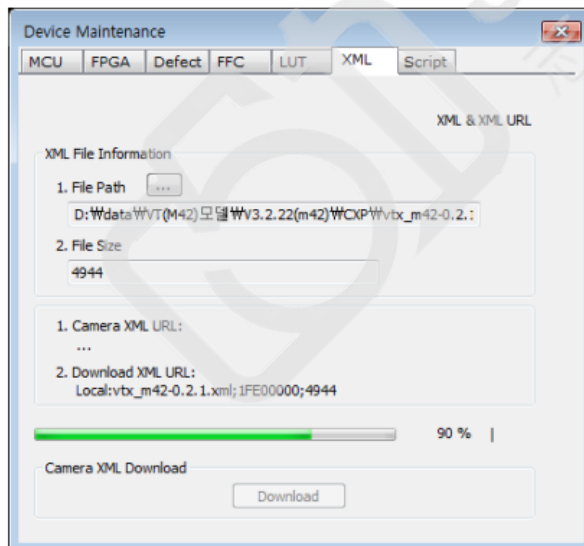



## Contact Information

---

<b>Webpage</b>	<a href="http://vision.vieworks.com">http://vision.vieworks.com</a>
<b>E-mail</b>	<a href="mailto:vision@vieworks.com">vision@vieworks.com</a>
<b>Phone</b>	+82-70-7011-6161
<b>Address</b>	Vieworks Co., Ltd. 41-3, Burim-ro, 170beon-gil, Dongan-gu, Anyang-si, Gyeonggi-do 14055 Republic of Korea

---