

# VPS-245MX2-M/C12H00

245 Megapixel Thermoelectric Peltier Cooled Camera  
with CoaXPress 2.0 Interface



**CoaXPress®**

The VPS-245MX2-M/C12H00 is a new 245-Megapixel CoaXPress camera based on IMX811, the latest BSI (Backside-Illuminated) CMOS image sensor technology, from Sony. It offers up to 12.4 frames per second at 19,200 x 12,800 resolution. It uses Thermo-electric Peltier (TEC) cooling technology developed for and used by many demanding medical market customers. The TEC maintains the operating temperature of the CMOS image sensor at up to 15 degrees below ambient temperature.

The VPS-245MX2-M/C12H00 provides a stable operating condition and the ability to expose for a long period of time to increase camera sensitivity. With advanced uniformity and high-speed image processing capabilities, it is ideal for demanding applications such as FPD, PCB and semiconductor inspections.

**VIEWORKS**

[vision.vieworks.com](http://vision.vieworks.com)

## Mechanical Dimensions

Unit: mm

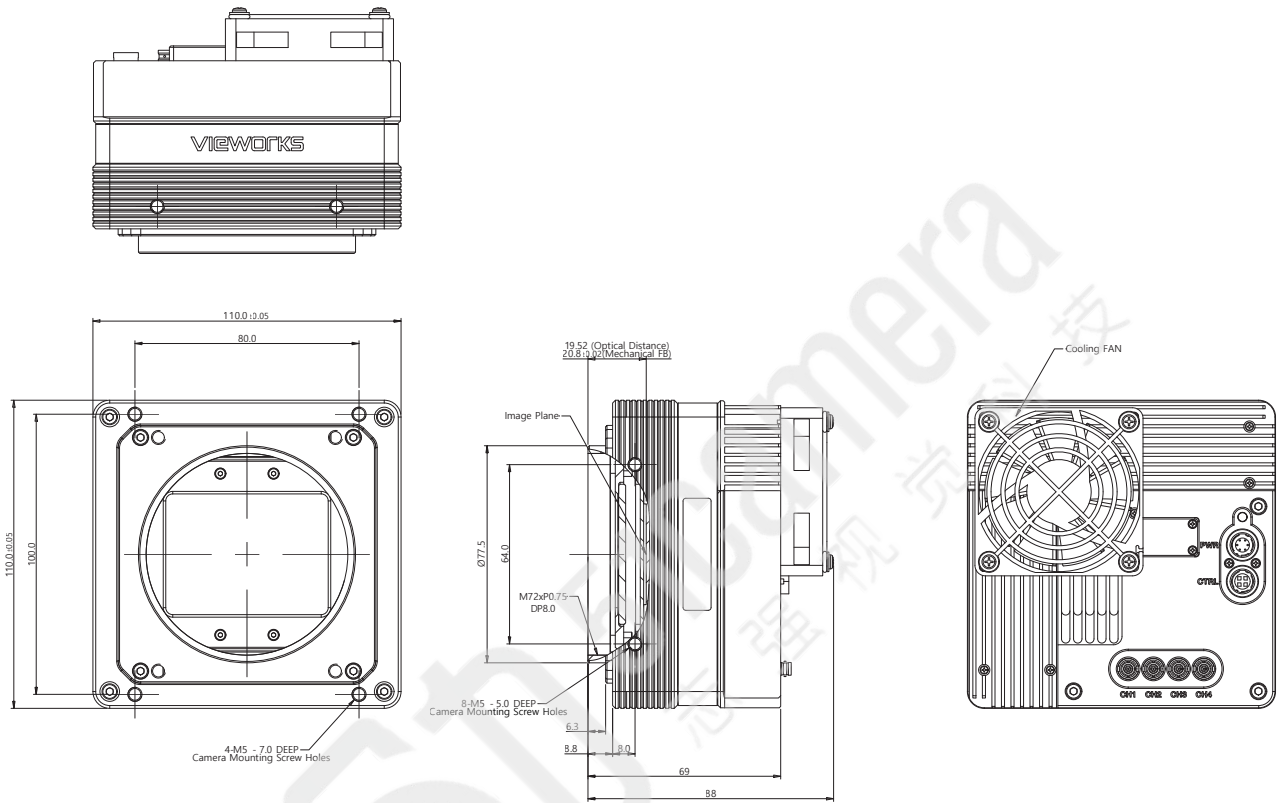

## Main Features

- Thermoelectric Peltier Cooled (15°C below)
- BSI (Backside Illuminated) CMOS Image Sensor
- CoaXPress 2.0 Interface up to 12.4 fps
- Rolling Shutter CMOS Technology
- DSNU and PRNU Correction
- Defective Pixel Correction
- Pixel by Pixel Flat Field Correction
- GenICam Compatible – XML based Control

## Applications

- Flat Panel Display Inspection
- PCB Inspection
- Electronics Inspection
- Semiconductor Inspection

## Specifications

Model		VPS-245MX2-M/C12H00
Resolution (H × V)		19,200 × 12,800
Sensor (Type)		SONY IMX811 (Back-Illuminated CMOS Image Sensor)
Sensor Size (Diagonal)		64.84 mm
Pixel Size		2.81 μm × 2.81 μm
Interface		CoaXPress 2.0 (CXP-12)
Max. Frame Rate (Trigger mode non-overlap)		12.4 fps @ 8/10/12 bit 10.56 fps @ 14 bit 5.31 fps @ 16 bit
Exposure Time (1 μs step)		98 μs to 59.6 s (1 μs step)
Pixel Data Format	Monochrome	8/10/12/14/16 bit
	Color	RG Bayer 8/10/12/14/16 bit
Electronic Shutter		Rolling Shutter
Exposure Mode		Timed, Trigger Width
Dynamic Range		72dB@12bit, 76dB@14bit, and 78dB@16bit
Gain	Digital Gain	×1 to ×32
	Analog Gain	×1× to ×16
Digital Black Level		0 to 4095 LSB at 16bit (1 LSB step)
Dimension / Weight		110.0 × 110.0 × 88.0 mm / 1,380 g
Cooling	Method	Thermoelectric Peltier Cooling
	Performance	15°C below ambient temperature – Standard cooling with a fan
Temperature		Operating: 0°C to 40°C, Storage: -40°C to 70°C
Trigger	Overlapped	Free-Run
Synchronization	Non-overlapped	Hardware Trigger, Software Trigger or CXP
External Trigger		3.3 V to 24.0 V, 10 mA, Logical Level Input Optically Isolated
Digital IO		TTL Level Exposure Active, Frame Active, User Output, Timer, Strobe Output
Lens Mount		M72-mount, Custom mount available upon request
Power	Adapter	11 to 24V DC
	Dissipation	Typ. 37 W
Compliance		CE, FCC, KC

## Relative Sensitivity Curves

\* The sensitivity data may not match the measurement on the finished product necessarily because it is measured based on the wafer.

- Mono

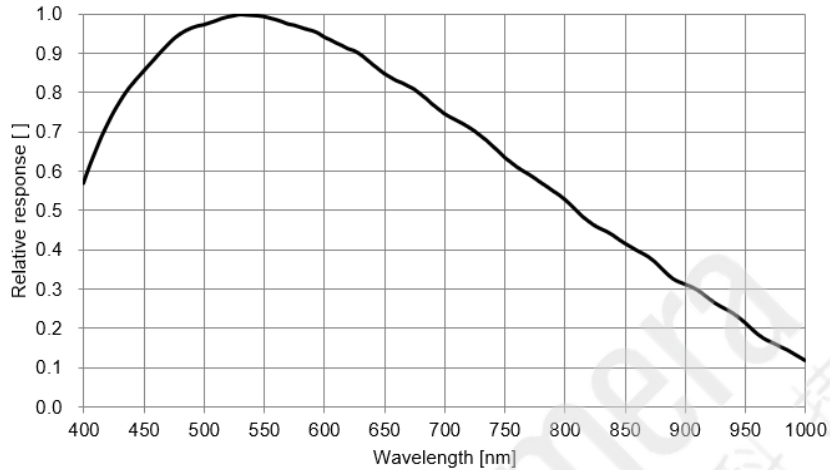

- Color

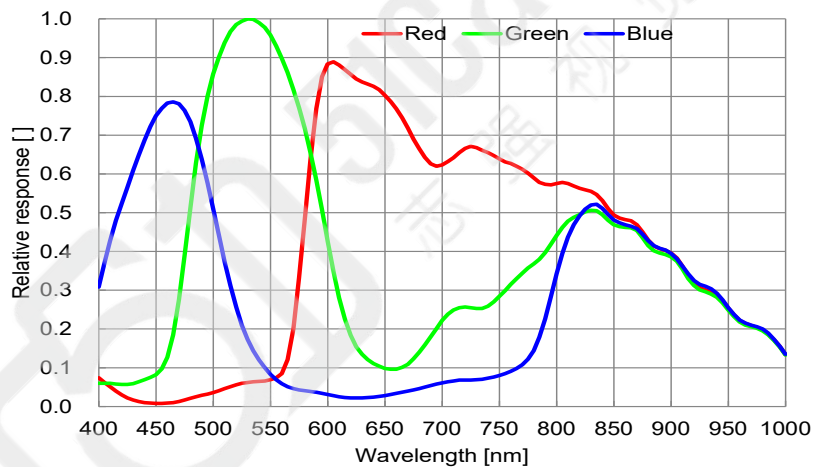

## Ordering Scheme

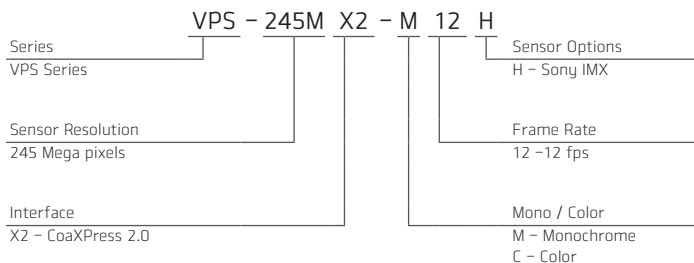

## Connector Specification

### Power

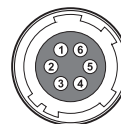

1, 2, 3: +12V DC  
4, 5, 6: GND  
(HR10A-7R-6PB)

### Control

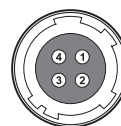

1: Trigger IN+  
2: Trigger IN-  
3: Strobe Out-(GND)  
4: Strobe Out+  
(HR10A-7R-4S)

### Data Transfer / Communications

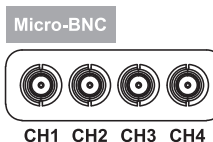

CH1: Master Connection  
75 Ω, Micro-BNC (HD-BNC)

Connectors on camera body