

VTS-9K5F-H550I-256

High Speed & High Sensitivity 9k TDI Camera
with Charge-domain BSI Image Sensor

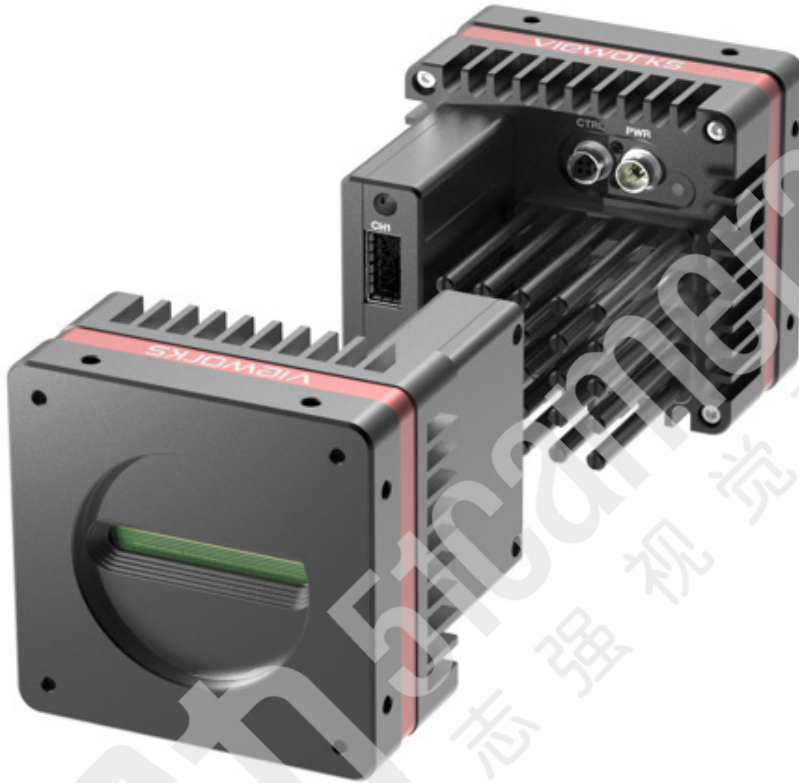

CoaPress[®]
over-Fiber

The VTS-9K5F-H550I-256 camera, the new Time Delayed Integration (TDI) camera with a Back-Side Illuminated (BSI) image sensor by charge-domain CMOS technology, provides faster line rates and higher sensitivity than existing TDI cameras.

With the state-of-the-art BSI sensor from Gpixel, the camera acquires images of 9k resolution with 256x higher sensitivity, and for higher than that, the camera also supports the HDR feature using both photosensitive bands, 256 stages and 32 stages respectively.

Featured with high speed and high sensitivity, the camera is ideal for demanding applications such as semiconductor inspection, PCB(Printed Circuit Board) inspection, flat panel display inspection, and fluorescence imaging.

VIEWORKS

vision.vieworks.com

VTS-9K5F-H550I-256

High Speed & High Sensitivity 9k TDI Camera



Mechanical Dimensions

- VTS-9K5F (Camera)

Unit: mm

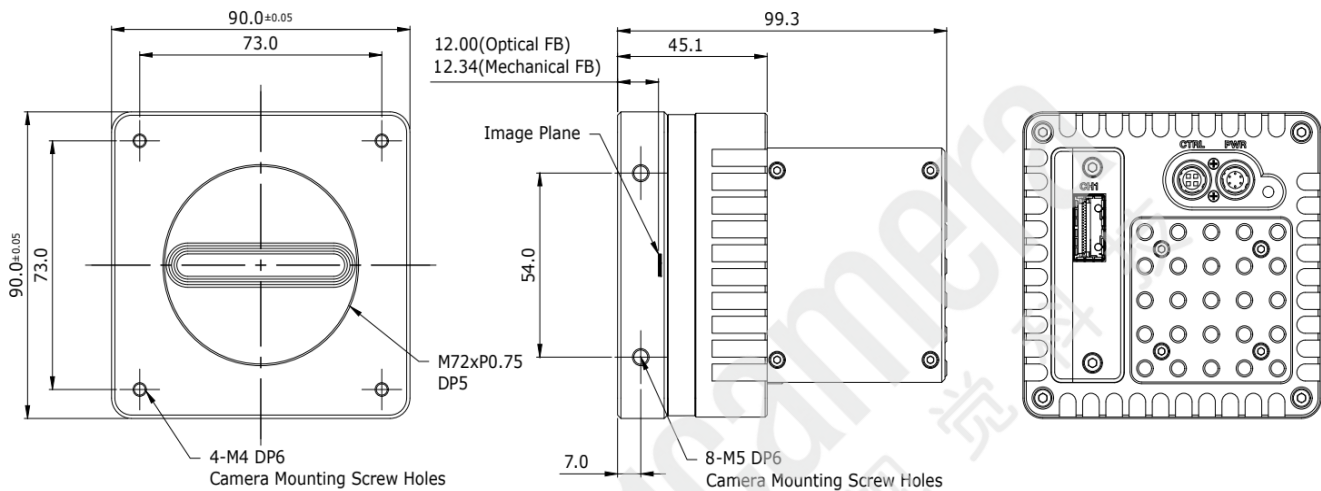

- VTS-9K5F (Camera + 1 Additional Heat Sink), Heatsink Size: 87mm x 39.5mm x 97.5mm

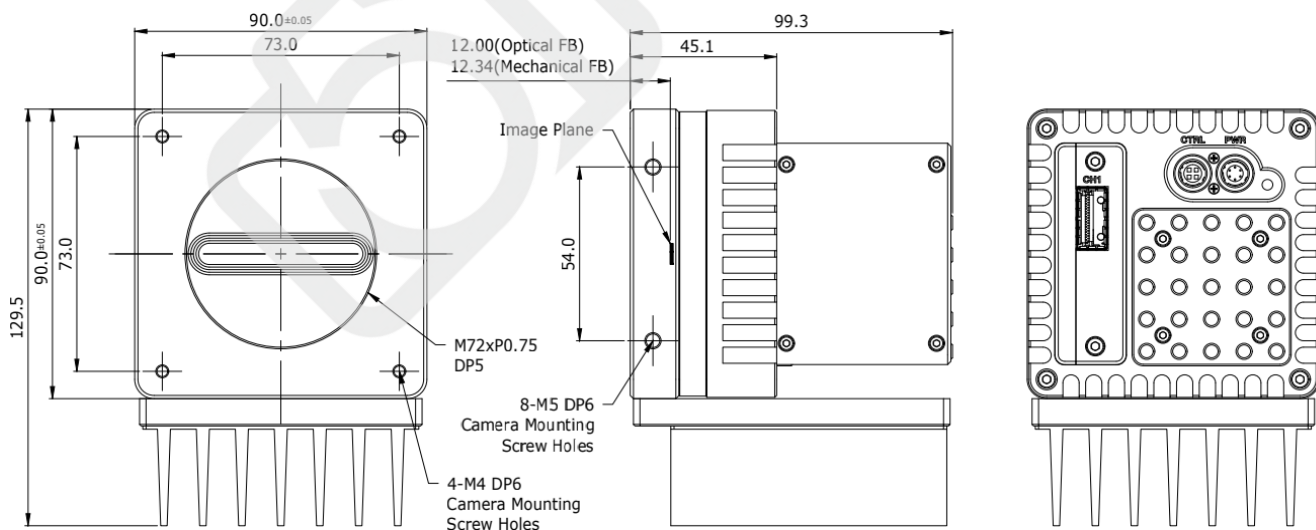

Main Features

- 9kTDI, BSI(Back-Side Illuminated), Charge-domain CMOS
- CoaXPRESS over Fiber Interface up to 40 Gbps using 1 Link
- Bidirectional Operation with up to 256 TDI Stages in a Single Band, or 32 TDI Stages in a Dual Band
- Advanced DSNU and PRNU Correction
- Strobe Output Control
- GenICam Compatible – XML based Control

Applications

- Semiconductor Inspection
- Printed Circuit Board Inspection
- Flat Panel Display Inspection
- Fluorescence Imaging

Specifications

Photosensitive Bands	Single Band (No HDR)	Dual Band (HDR)
Resolution (H × V)	9056 × 256	9056 × (256 + 32)
Sensor	Back-Side Illuminated Image Sensor (GLT5009BSI)	
Interface	CoaXPRESS over Fiber	
Connection	QSFP+ Single-channel CoF Frame Grabber × 1 Optic Transceiver(40G QSFP+ SR4) × 2 Optic Cable(MPO female to MPO female, type B) × 1	
Pixel Size	5.0 μm × 5.0 μm	
Sensor Size (diagonal)	45.36 mm × 1.28 mm	45.36 mm × (1.28 + 0.16) mm
Max. Line Rate	8 bit: 543 kHz 10 bit: 435 kHz 12 bit: 300 kHz	8 bit: 271.5 kHz × 2 10 bit: 217.5 kHz × 2
Min. Line Rate	30 kHz	
Pixel Data Format	Mono 8/10/12 bit	Mono 8/10 bit
TDI Stages	4/8/16/32/64/96/128/160/192/224/240/248/252/256	
	OFF	2/4/8/16/24/28/30/32
Trigger Synchronization	Free-Run, External or CoaXPRESS 2.0	
Throughput	4.9 Gpixels	
Gamma Correction	User Defined Lookup Table (LUT)	
Black Level Control	-256 ~ 255 at 8 bit	
Gain Control	Analog Gain	2.0× ~ 8.0×
	Digital Gain	1.0× ~ 32.0×
Lens Mount	M58 × 0.75 mm	
Dimension / Weight	90 mm × 90 mm × 99.3 mm, 950 g (Basic)	
	90 mm × 129.5 mm × 99.3 mm, 1270 g (with more Heat-sink)	
Temperature	Ambient Operating: 0°C ~ 40°C (Housing: 10°C ~ 55°C), Storage: -40°C ~ 70°C	
Power	External	11 ~ 24 VDC
	Dissipation	Typ. 25.2 W
Compliance	CE, FCC, KC	
API SDK	Vieworks Imaging Solution 7.4.X	

Quantum Efficiency

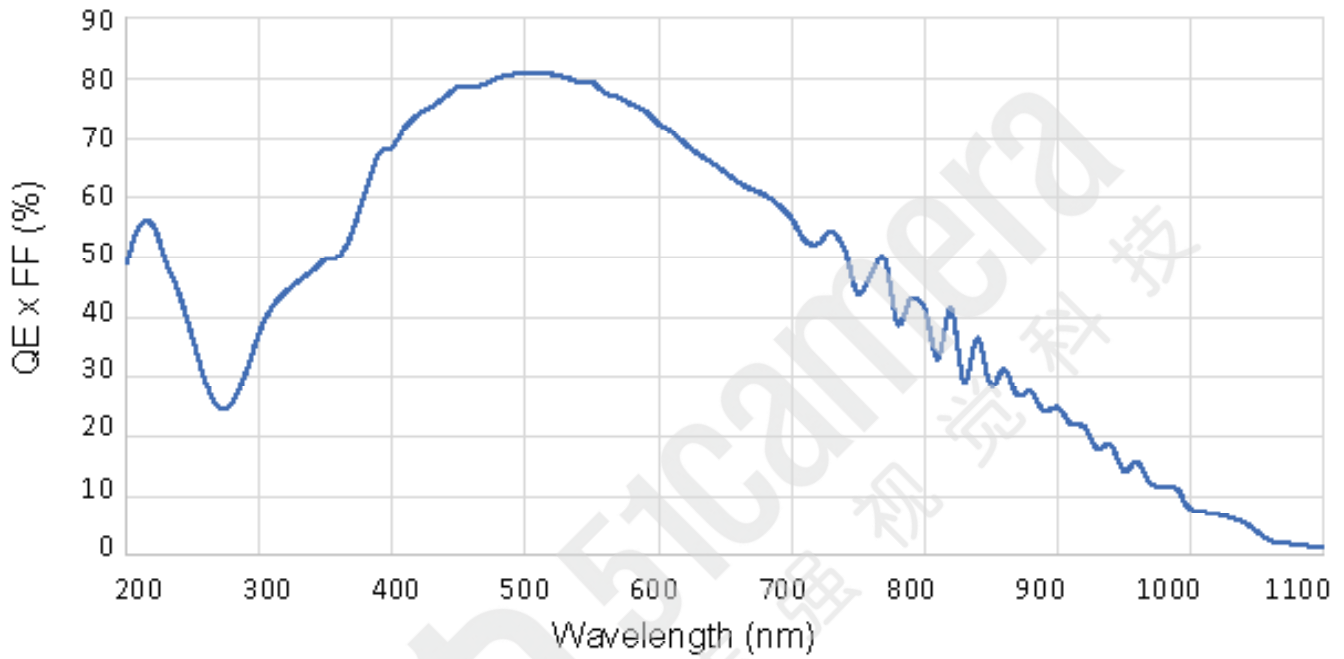

Ordering Scheme

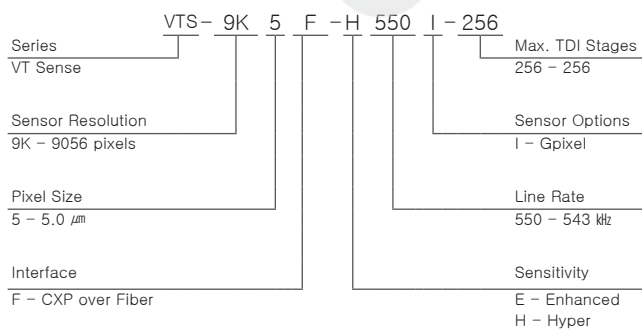

Connector Specification

Power

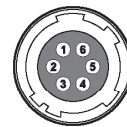

1 2 3: +12 VDC, 4 5 6: GND
(HR10A-7R-6PB)

Control

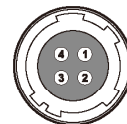

1: Trigger IN, 2: Direction IN
3: DC Ground, 4: Strobe OUT+
(HR10A-7R-4S)

Data Transfer / Communications

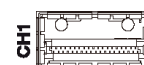

CH1: Master Connection and QSFP+