

Control Unit for LED Light Units

PD3-3024-3-ET(A)

With Ethernet communications

Instruction Guide

Thank you for purchasing a CCS product. To ensure proper use of the product, please read this Instruction Guide before use and keep it for your future reference.



This Control Unit is specifically designed to control the light intensity of CCS LED Light Units. It is mainly used to control LED Light Units that are used for machine vision and industrial inspections.

Features

- One Control Unit can individually control three different Light Units.
- The light intensity can be manually controlled with a dial on the front panel, or externally controlled using Ethernet.
- PWM control is used to control the light intensity at a frequency of 125 kHz.
- TCP/IP and UDP/IP Ethernet communications can be used for external control.
- External trigger inputs can be used to turn lights ON or OFF, or to strobe lights.
- The Control Unit can be used for CCS LED Light Units with a voltage of 24 V and a power consumption of up to 28 W. The total power consumption of the connected Light Units must be 28 W or less.

INDEX

| | | | |
|--|---|--|---|
| 1. Important Information for Equipment Safety | 1 | 8. Inputting an External Trigger | 5 |
| 2. Names and Functions of Parts | 2 | 9. Troubleshooting | 5 |
| 3. Installation | 2 | 10. Main Specifications | 6 |
| 4. Connections | 2 | 11. Dimensions | 6 |
| 5. What You Can Achieve with This Control Unit | 3 | 12. Optional Accessories | 6 |
| 6. Manual Control | 3 | | |
| 7. Control with External Signals | 4 | | |

1 Important Information for Equipment Safety — Read before Use —

This product has been designed with full consideration of safety. Incorrect usage of the product may result in fire, electric shock, or other serious damages. Observe the following precautions.

The following symbols are used in this instruction guide to indicate and classify the relative importance of warnings and cautions.

| | | | | | |
|--|----------------|---|--|----------------|---|
| | WARNING | Indicates that incorrect usage may result in serious injury or death. | | Caution | Indicates that incorrect usage may result in injury or property damage. |
|--|----------------|---|--|----------------|---|

The following symbols in the instruction guide indicate and classify the precautions.

| | | | | |
|--|------------------------|-----------------------------|----------------------------|---|
| | | | | |
| PROHIBITED | DISASSEMBLY PROHIBITED | DO NOT TOUCH WITH WET HANDS | DO NOT SUBJECT TO MOISTURE | MANDATORY ACTIONS |
| These symbols indicate prohibited actions. | | | | This symbol indicates required actions. |

| | | | |
|---|--|--|--|
| | | WARNING | |
| Do not disassemble or modify the Control Unit. Doing so may result in fire or electric shock. | | Do not touch the plugs or switches with wet hands. Doing so may result in electric shock. | |
| Make sure that the Control Unit is free of moisture or any liquid. Doing so may result in fire or electric shock. | | Before connecting or disconnecting cables, make sure that the power source is turned OFF. Not doing so may result in fire or electric shock. | |
| Do not touch the power cords during lightning. This may result in electric shock. | | If abnormal condition occurs such as fuming, heat, smell, noise, or so on, stop using the Control Unit immediately, and turn off the power source. A fire or electric shock may result if the Control Unit is kept used. | |

| | | | |
|---|--|--|--|
| | | Caution | |
| Do not connect any Light Units other than CCS LED Light Units. Doing so may cause overcurrent and the device may overheat or ignite. | | Do not bundle Control Unit cables with high-voltage lines or power lines. Allow leeway when installing the cables. | |
| Do not use user-made branch cables. Doing so may cause Control Unit failure. | | Use Light Units that are suitable for the Control Unit ratings. Exceeding the ratings may cause Control Unit failure. | |
| Do not place the Control Unit in direct sunlight or in a high-humidity environment. Doing so may result in fire due to internal temperature rise. | | Use a standard Extension Cable that is manufactured by CCS. However, if the cable is too long, the light intensity will decrease due to voltage drop caused by the DC resistance of the cable. | |
| Always place the Control Unit on a stable and flat location. Not doing so may result in the Control Unit falling or toppling, which may cause malfunction, accidents, or bodily injury. | | Always hold onto the plug or connector when disconnecting the cables. Pulling on the cable may damage the cable and result in fire or electric shock. | |
| Do not drop the Control Unit or subject it to impact. Doing so may cause Control Unit failure. | | Before moving the Control Unit, disconnect all connection cables. Damaging the cables may result in fire or electric shock. | |
| Do not bend cables or jam them between objects when wiring. Doing so may cause Control Unit failure. | | When mounting the Control Units in system racks or cases, do not insert the screws more than 5 mm. Doing so may cause short-circuits in internal components. | |
| Do not intentionally short-circuit the positive and negative output terminals. | | Use a dry cloth to remove dust or other foreign matter from the electrodes. Failure to do so may result in fire. | |
| Be sure to use the Control Unit within the range of input voltage. Applying the voltage beyond the range may cause Control Unit failure. | | Do not wipe the Control Unit with volatiles such as paint thinner or benzene. Discoloration or deterioration of the Control Unit surfaces may occur. | |

2 Names and Functions of Parts

Setting Indicators

BRT lit: The light intensity can be set.
 PLS lit: The lighting mode can be set.
 LOCK lit: The settings are locked.

Channel Selection Switch

Selects L1, L2, or L3.

External Control Connector

Used for external control with Ethernet communications.

External Control Reset Switch

Pressed with a pointed object to reset network settings to their default values.

Manual/External Mode Selector

Selects manual (MANU) or external (EXT) control mode.

Trigger Logic Switch

Selects the logic of the trigger signal.

Terminal Block

Connects the power source to the Control Unit.

Terminal Block Cover

Attached to the Terminal Block in shipping.

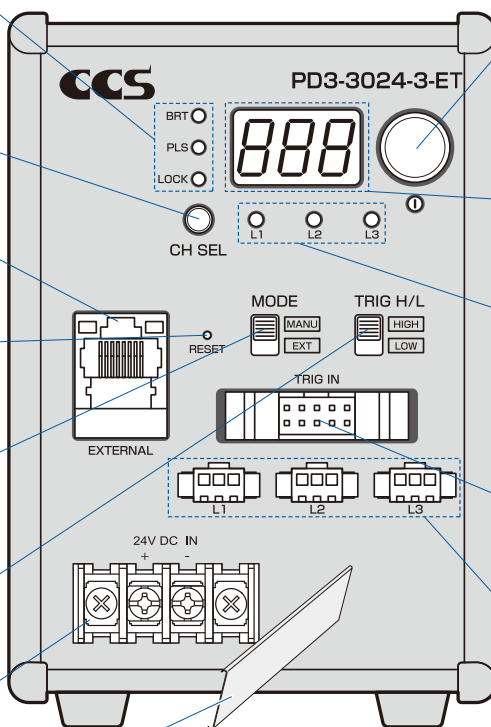

Setting Switch

Press: Switches between the light intensity setting and lighting mode setting.

Press for at least 2 seconds:
 Locks the settings.

Rotate: Sets the light intensity or lighting mode.

Digital Display

Displays the setting of the light intensity or the setting of the lighting mode.

Channel Indicators

L1 lit: Lit when changing settings for Light Unit connected to output connector L1.

L2 lit: Lit when changing settings for Light Unit connected to output connector L2.

L3 lit: Lit when changing settings for Light Unit connected to output connector L3.

External Trigger Input Connector

Inputs the ON/OFF signal for ON/OFF Mode.
 Inputs the trigger signal for Strobe Mode.

Output Connectors

Supply power to the Light Units.

3 Installation

WARNING Do not place any objects within 20mm from the air vents on the side panels. Insufficient ventilation may cause heat to accumulate inside the product and result in a fire.

Mounting the Unit to DIN Rail

▶ Mounting to DIN Rail

Hook the tab on the upper part of the Unit on the DIN rail and press the Unit in the direction indicated by arrow 2 while pressing it in the direction indicated by arrow 1.

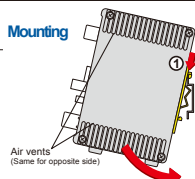

▶ Removing from DIN Rail

Press the Unit down in the direction indicated by arrow 3 and pull it out in the direction indicated by arrow 4.

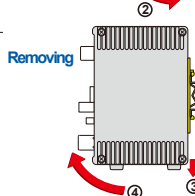

Securing the Unit with Base Brackets (Optional, Sold Separately)

Always use Base Brackets (model: BK-PD3) when securing the Unit at its base. If it is secured without the Brackets, the Unit may be damaged.

1 Removing the Rubber Feet from the Bottom of the Unit

Remove the screws that hold the rubber feet in place using a Phillips screwdriver.

2 Securing the Brackets to the Base of the Unit

Secure the Brackets to the base of the Unit with the four screws that come with the Brackets.

3 Securing the Unit with Mounting Screws

Secure the Unit in place with mounting screws. The mounting screws must be provided by the user.

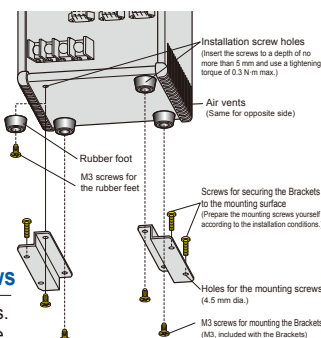

4 Connections

WARNING Before connecting the Control Unit, make sure that the main power source is turned OFF. Making connections with the power turned ON may result in a fire or electric shock.

Output Connectors (L1 to L3)

Connecting

Insert the connector to the Light Unit all the way in.

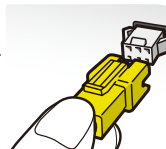

Removing

Press the lock and pull out the connector.

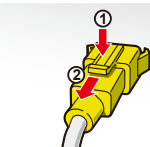

External Trigger Input Connector (TRIG IN)

Connecting

Press the connector in until it locks in place.

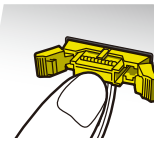

Removing

Release the lock and remove the connector.

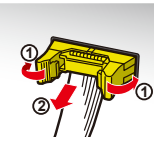

*An optional External Trigger Input Cable (EXCB2-M10-3) (sold separately) is available. In case using a self-made cable, cable length should be within 3 m at maximum.

External Control Connector (EXTERNAL)

Connecting

Firmly insert the connector of the LAN cable.

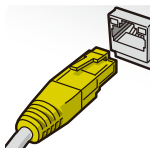

Removing

Press the lock and pull out the connector.

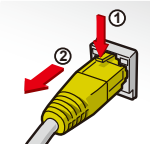

*The LAN cable must be provided by the customer. (Cable length should be within 30 m at maximum.)

This product recognizes either cross-cable or straight-cable automatically by auto-negotiation function. Please reboot the product when changing the cable.

Terminal Block

Connect the power cord to the Terminal Block and the main power source, then attach the Terminal Block Cover onto the Terminal Block.

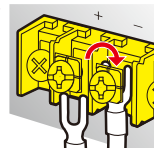

The Control Unit will turn ON when power is supplied from the main power source. When the Unit is ON, the digital display will light.

Caution

- Be sure to connect cables properly with insulated M3 crimp terminals (width: 6.2mm max.). Improper connections may cause fires or product failure.
- Pay attention to the polarity(+/-) when connecting the power cord.

5 What You Can Achieve with This Control Unit

Select the control mode and lighting mode from the following Application Guide and proceed to the indicated reference items.

*Data that has been set is retained even after the power is turned OFF with manual or external control.

Application Guide

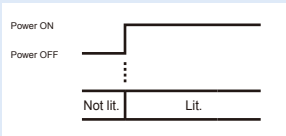
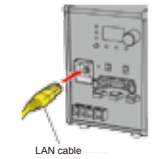
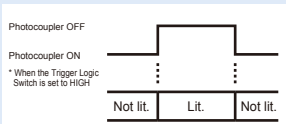
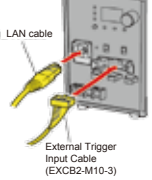
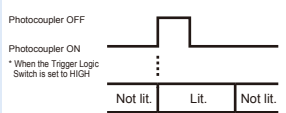
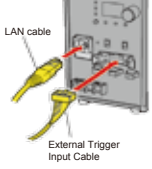
| | Control mode | MODE ↑ MANU EXT | Front panel operation | MODE ↓ MANU EXT | External control using a PLC or image process device |
|---------------|-----------------|--------------------------|--|--------------------------|--|
| Lighting mode | Continuous Mode | | The Light Units are always ON.  | | To use external control in Continuous Mode, refer to items 1 , 2 , and 3 under 7 Control with External Signals .  |
| | ON/OFF Mode | | The Light Units are turned ON or OFF according to the external trigger signal input.  * It is possible to turn LED light unit ON and OFF by Ethernet communications, too. | | External trigger signal or Ethernet communications setting can be selected when using ON/OFF mode by external control. To use external trigger signal in ON/OFF mode, refer to items 1 , 2 , and 3 under 7 Control with External Signals and 8 Inputting the External Trigger . To use Ethernet communications setting in ON/OFF mode, refer to items 1 , 2 , 3 , and 5 under 7 Control with External Signals .  |
| | Strobe Mode | | The Light Units are turned ON for a set time after the external trigger signal is input.  * When the Trigger Logic Switch is set to HIGH | | To use external control in Strobe Mode, refer to items 1 , 2 , 3 , and 4 under 7 Control with External Signals and 8 Inputting the External Trigger .  |

6 Manual Control

- Make sure that the main power source is turned ON.
- Set items **1**, **2**, and **3** when using Continuous Mode or ON/OFF Mode.*
- Set items **1**, **2**, **3**, and **4** when using Strobe Mode.

* If you have changed the lighting mode from the default value, set it to "Continuous Mode or ON/OFF Mode" in item **4**.

1 Setting the Manual/External Mode Selector to Manual

Set the Manual/External Mode Selector to MANU to set Manual Mode.

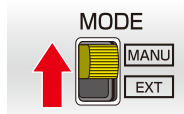

Check

Make sure that the LOCK setting indicator is not light and that the trigger logic switch is set to HIGH. Otherwise you may not be able to perform the rest of this procedure.

2 Selecting the Channel

Press the channel selection switch to select the channel to set (L1 to L3). The channel indicators will change.

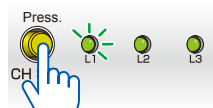

3 Setting the light Intensity

Press the setting switch to light the BRT setting indicator.

Turn the setting switch to set a value between 0 and 255. (Default setting: 000, Minimum: 000, Maximum: 255)
* The Light Units are light dimly at the minimum value.

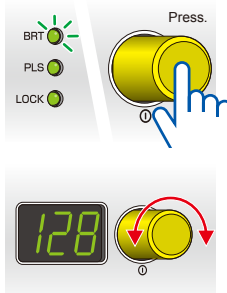

4 Selecting the Lighting Mode

Press the setting switch to light the PLS setting indicator.

Turn the setting switch to select the lighting mode from Continuous Mode, ON/OFF Mode, or Strobe Mode.

(Default value: [F00])

Continuous Mode

Turn the setting switch and set [F00] to turn ON the Light Units continuously.

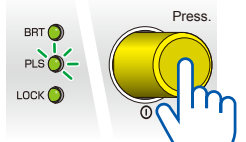

ON/OFF Mode (If the external trigger is not used, the Light Units are ON continuously.)

Turn the setting switch and set [F00] to turn the Light Units ON and OFF. The Light Units are turned ON or OFF according to the external trigger signal input.

Strobe Mode (If an external trigger is not used, the Light Units are OFF.)

To flash the strobe, turn the setting switch and select a setting from [F01 to F10] (strobe time of 40 μs to 40 ms). The Light Units are turned ON for the period of time set on the setting switch after the external trigger signal is input.



| Digital display | F00 | F01 | F02 | F03 | F04 | F05 | F06 | F07 | F08 | F09 | F10 |
|-----------------|--------------------------------|-------------|-------|--------|--------|--------|------|------|-------|-------|-------|
| Status | Continuous Mode or ON/OFF Mode | Strobe Mode | | | | | | | | | |
| | | 40 μs | 80 μs | 120 μs | 200 μs | 600 μs | 1 ms | 4 ms | 10 ms | 20 ms | 40 ms |

For details on the external trigger input, refer to 8. Inputting the External Trigger.

Locking Settings

When the setting switch is pressed for 2 seconds or longer, the lighting mode and light intensity settings are locked, and the LOCK setting indicator lights. (The set values can be viewed.) Pressing the switch again for 2 seconds or longer releases the lock.

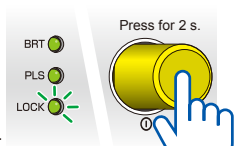

7 Control with External Signals

An external device such as a PLC or image processing device transmits the send data to the Control Unit. The Control Unit processes the data and returns the results. The external device gets the receive data as the execution results.

Communications Specifications TCP/IP protocol or UDP/IP protocol (Switching operation is not required.), and Ethernet (Baud rate: 10 Mbps or 100 Mbps, automatically detected; Transmission medium: 10BASE-T or 100BASE-TX)
 Note: The Control Unit supports only one TCP connection at one time.

Command Formats

Sample of Alphanumeric Characters: ABCDEFGHIJKLMNOPQRSTUVWXYZ 0123456789

Send Data (*1)

| Function | Header | Channel specification | Send command | | Checksum | Delimiter | Default (*4) | | | |
|----------------------------------|--------|---|--------------|---|----------------------------------|-----------|---|-----------------|--|--|
| | | | Command | Data (*2) | | | | | | |
| Light Intensity Setting | @ | 00 to 02 (Refer to Channel Specification.) FF: All channels (F command used for the batch setting for each channel and L command only) | F | 000 to 255 (000: Minimum intensity, 255: Maximum intensity) | 00 to FF (Refer to Checksum.) | <CR><LF> | 000 | | | |
| Lighting Mode Setting | | | S | 00 to 10 (Refer to Lighting Mode Settings.) | | | 00 | | | |
| ON/OFF Setting | | | L | 0: Not lit, 1: Lit (Refer to *3) | | | 1 | | | |
| Setting Status Check | | | M | --- | | | --- | | | |
| Status Check (overcurrent check) | | | C | --- | | | --- | | | |
| All Channel Initialization | | | R | --- | | | --- | | | |
| IP Address | | | E01 | 00 (fixed) | | | 000.000.000.000 to 255.255.255.255 (Specify all digits, e.g., specify "192.168.000.005" instead of "192.168.0.5.") | 192.168.000.002 | | |
| Subnet Mask | | | E02 | | | | | 255.255.255.000 | | |
| Default Gateway | | | E03 | | | | | 192.168.000.001 | | |
| Reply IP Address | | | E05 | | | | | 192.168.000.016 | | |
| Reception Port Setting | | | E04 | | | | | 40001 | | |
| Reply Port Setting | | | E06 | | | | | 30001 | | |
| | | | | | | | 00000 to 65535 (Specify all digits, e.g., specify "04561" instead of "4561.") | | | |

*1 Send a data within 4 seconds from 'Header' to 'Delimiter', otherwise time-out error occurs and command data will be rejected.
 *2 Specify all numbers in decimal format.
 *3 ON/OFF setting from Ethernet communications without regards to trigger logic switch, turned OFF at '0' and ON at '1'.
 When operating Ethernet communications and trigger signal input at same time in ON/OFF mode. When Trigger logic switch is at HIGH: if either controls setting to OFF setting, Light unit will be turned OFF. When Trigger logic switch is at LOW: if either controls setting to ON setting, Light unit will be turned ON.
 *4 Except for the ON/OFF setting, any changes to the above default values will be held after the power supply is turned OFF. The ON/OFF setting will not be held.

Receive Data (*5)

| Function | Header | Channel specification | Receive command | | | Checksum | Delimiter |
|----------------------------------|--------|---|-----------------|---------------------------|---|----------------------------------|-----------|
| | | | OK | NG | | | |
| Light Intensity Setting | @ | 00 to 02 (Refer to Channel Specification.) FF: All channels (F command used for the batch setting for each channel and L command only) | O | --- | N | 00 to FF (Refer to Checksum.) | <CR><LF> |
| Lighting Mode Setting | | | | --- | | | |
| ON/OFF Setting | | | | --- | | | |
| Setting Status Check | | | | F999.S99.L9 (Refer to *6) | | | |
| Status Check (overcurrent check) | | | | 00: Normal, 11: Error | | | |
| All Channel Initialization | | | | --- | | | |
| IP Address | | | | --- | | | |
| Subnet Mask | | | | --- | | | |
| Default Gateway | | | | --- | | | |
| Reply IP Address | | | | --- | | | |
| Reception Port Setting | | | | --- | | | |
| Reply Port Setting | | | | --- | | | |

*5 There is no received data when timeout error occurs.
 *6 Received Command for Setting Status Check (F999.S99.L9): F999 = F command set value (F000 to F255), S99 = S command set value (S00 to S10), L9 = L command set value (L0: Not lit, L1: Lit) L1 must be returned immediately after the power supply is turned ON.

Channel Specification

| Channel | L1 | L2 | L3 |
|-----------|----|----|----|
| Set value | 00 | 01 | 02 |

* Set values that are higher than 02 are not valid.

Lighting Mode Settings

| Status | Continuous Mode or ON/OFF Mode | Strobe Mode | | | | | | | | | | | |
|-----------------|--------------------------------|-------------|-------|--------|--------|--------|------|------|-------|-------|-------|--|--|
| | | 40 μs | 80 μs | 120 μs | 200 μs | 600 μs | 1 ms | 4 ms | 10 ms | 20 ms | 40 ms | | |
| Digital display | F00 | F01 | F02 | F03 | F04 | F05 | F06 | F07 | F08 | F09 | F10 | | |
| Set value | 00 | 01 | 02 | 03 | 04 | 05 | 06 | 07 | 08 | 09 | 10 | | |

* Set values that are higher than 10 are not valid.

Batch Setting for Each Channel (Available Only When "FF" Is Set for the Channel Specification)

When you specify the data in the form "aaa/bbb/cc" to the F command, you can set the light intensities for each channel with a single send data at a time. If you specify "FFF" for a data, the light intensity of the corresponding channel will not be changed.

Example) @FFF123/045/FFF71CRLF: Setting the L1 light intensity to 123, L2 light intensity to 045. The L3 light intensity will not be changed.

When you specify the data in the form "a/b/c" to the L command, you can set ON/OFF signals for each channel with a single send data at a time. If you specify "F" for a data, the ON/OFF status of the corresponding channel will not be changed.

Example) @FFL1F/01DCRLF: Setting the L1 signal to ON. The L2 ON/OFF status will not be changed. Setting the L3 signal to OFF.

Checksum

The codes of the ASCII characters from the header to the send command are added, the lowest byte is converted to hexadecimal, and two characters are sent.

Example: Setting the Light Intensity of Channel 2 to 125

| Character | Header | Channel | | | Sent command | | | Total |
|---------------------|--------|---------|--------|--------|--------------|--------|--------|---------|
| | Byte 1 | Byte 2 | Byte 3 | Byte 4 | Byte 5 | Byte 6 | Byte 7 | |
| ASCII (hexadecimal) | @ | 0 | 1 | F | 1 | 2 | 5 | |
| ASCII (hexadecimal) | 40 hex | 30 hex | 31 hex | 46 hex | 31 hex | 32 hex | 35 hex | 17F hex |

* The lowest byte (two characters) of 17F is taken, so the checksum is 7F.

Setting Procedures

- Make sure that the main power source is turned ON.
- Set items 1, 2, and 3 when using Continuous Mode.*
- Set items 1, 2, 3, and 5 when using ON/OFF Mode.*
- Set items 1, 2, 3, and 4 when using Strobe Mode.

* If you have changed the lighting mode from the default value, set it to "Continuous Mode or ON/OFF Mode" in item 4.

1 Setting the Manual/External Mode Selector to External

Set the Manual/External Mode Selector to EXT to set External Mode. The value set with external control is displayed on the digital display.

* Although it is possible to set the external control setting even the manual/external mode selector is set to manual mode, the setting will not be activated until the manual/external mode selector is set to external mode.

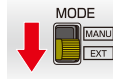

2 Setting Up the Network (Only Initially and When Settings Are Changed)

Set the Unit's IP address and the reply address.

To enable the settings that were changed, cycle the power supply.

* If the IP address changes, do not forget to change the send destination of commands.

| Item | Setting example | Send data |
|------------------------|-----------------|-----------------------------|
| IP Address | 192.168.3.2 | @00E01192.168.003.00230CRLF |
| Subnet Mask | 255.255.255.0 | @00E02255.255.255.00035CRLF |
| Default Gateway | 192.168.3.1 | @00E03192.168.003.00131CRLF |
| Reception Port Setting | 4561 | @00E040456149CRLF |
| Reply IP Address | 192.168.3.10 | @00E05192.168.003.01033CRLF |
| Reply Port Setting | 4562 | @00E06045624CCRLF |

| Item | Receive data when OK | Receive data when NG |
|------------------------|----------------------|--|
| IP Address | | @00N014FCRLF (when there is a command error) |
| Subnet Mask | | |
| Default Gateway | | |
| Reception Port Setting | @000EFCRLF | |
| Reply IP Address | | @00N0351CRLF (when there is a set value out of range error) |
| Reply Port Setting | | |

3 Setting the Light Intensity

Specify the channel and set the light intensity.

| Setting example | Send data | Receive data when OK | Receive data when NG |
|--------------------------------------|---------------|----------------------|---|
| Setting the L3 light intensity to 75 | @02F07584CRLF | @020F1CRLF | @00N014FCRLF (when there is a command error) |

4 Setting the Lighting Mode

Specify the channel and set the lighting mode.

| Setting example | Send data | Receive data when OK | Receive data when NG |
|---|--------------|----------------------|--|
| Setting the L2 lighting mode to 200 μs in Strobe Mode | @01S0458CRLF | @010F0CRLF | @01N0352CRLF (when there is a set value out of range error) |

5 To Set ON/OFF Signal in ON/OFF Mode

Specify the channel and set ON/OFF signal.

| Setting example | Send data | Receive data when OK | Receive data when NG |
|-----------------------------|-------------|----------------------|--|
| To turn all light units OFF | @FLL048CRLF | @FFO1BCRLF | @FFN027CCRLF (When there is checksum error) |

To Check the Setting Status

When checking the setting status, send the following command after specify the channel.

| Setting example | Send data | Receive data when OK | Receive data when NG |
|------------------------------------|------------|---|--|
| To check the setting status of L1. | @00MEDCRLF | @00OF075.S04.L060CRLF (If Intensity=75, Strobe mode=200μs, Light unit=OFF) | @00N0250CRLF (When there is checksum error) |

Checking the Unit Status

Send the following command to check the Unit status.

| Setting | Send data | Receive data when OK | Receive data when NG |
|--------------------------|------------|--------------------------|--|
| Checking the Unit status | @00CE3CRLF | @00O004FCRLF (normal) | @00N0351CRLF (when there is a set value out of range error) |

Resetting the Light Intensity and Lighting Mode

To restore the external control setting to default value, send the following command.

| Setting | Send data | Receive data when OK | Receive data when NG |
|----------------------------|------------|----------------------|---|
| All Channel Initialization | @00RF2CRLF | @00O0EFCRLF | @00N014FCRLF (when there is a command error) |

Initialize the Network Setting

If the IP address setting and others is incorrect, you will not be able to connect to the Control Unit. You will also not be able to reset the IP address and others. If that occurs, use a pointed object to press the external control reset switch on the front panel to reset network settings to their default values.

To enable the reset settings, cycle the power supply



8 Inputting an External Trigger

▶ Input Signal and Photocoupler

The input signal from the external trigger input connector can be used to control the photocoupler inside the Unit to turn the LED Light Units ON and OFF or to control strobe timing.

The operation depends on the setting of the trigger logic switch.

| Trigger Logic Switch | Input signal | Photocoupler | ON/OFF Mode | Strobe Mode |
|----------------------|--------------|--------------|-----------------|----------------------------------|
| HIGH | HIGH | OFF | Light Units ON | Light Units ON for the set time. |
| | LOW | ON | Light Units OFF | No change |
| LOW | HIGH | OFF | Light Units OFF | No change |
| | LOW | ON | Light Units ON | Light Units ON for the set time. |

* When operating trigger signal input and Ethernet communications at same time in ON/OFF mode.
When Trigger logic switch is at HIGH: if either controls setting to OFF setting, Light unit will be turned OFF
When Trigger logic switch is at LOW: if either controls setting to ON setting, Light unit will be turned ON

▶ Connector Layout

External Trigger Input Connector Plug

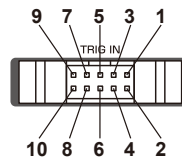

| No. | Signal | Cable (EXCB2-M10-3) | |
|--------|--------------------------------------|---------------------|---------|
| | | Wire color | Marks |
| 1 | Light Unit ON/OFF control input (L1) | Orange | Black 1 |
| 2 | Light Unit ON/OFF control input (L2) | Orange | Red 1 |
| 3 | Light Unit ON/OFF control input (L3) | Gray | Black 1 |
| 4 to 9 | Not used. | --- | --- |
| 10 | COMMON+ | Pink | Red 1 |

Example: Pin No. 10, pink, red 1



▶ Setting Procedures

With the external trigger input connector pins 1 to 3, select the channels (L1 to L3) where you want to input an external trigger, and input the trigger.

Trigger signals are input from the external trigger input connector in ON/OFF Mode and Strobe Mode in both Manual Mode or External Mode.

ON/OFF Mode

The Light Units are turned ON or OFF according to the external trigger signal input.

Strobe Mode

The Light Units are turned ON for the set time after the external trigger signal is input.

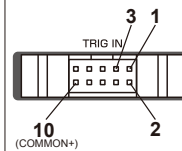

▶ External Trigger Signal Connection Example

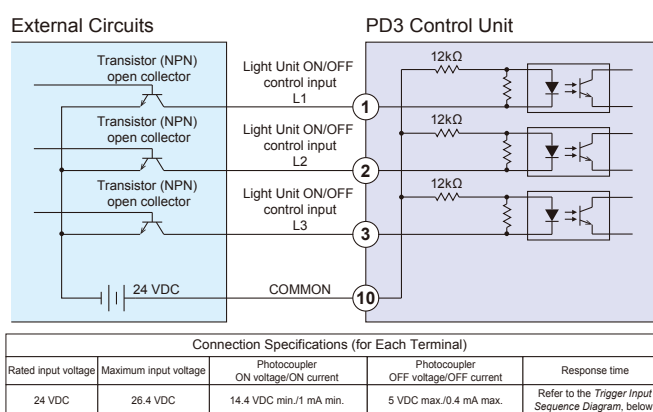

▶ Trigger Input Sequence Diagram

- A pulse width of ON signal shall be 10 μ s or more. The Light Units will be turned on for at least 40 μ s, even when the input ON signal is less than 40 μ s.
- If another trigger is input before the Light Unit turns OFF in Strobe Mode, the starting point of the reentered trigger is taken as the start time and the strobe light continues for the set time from that point.

ON/OFF Mode



● Trigger Logic Switch Set to HIGH

The Light Units turn ON when the photocoupler is OFF, and OFF when the photocoupler is ON.

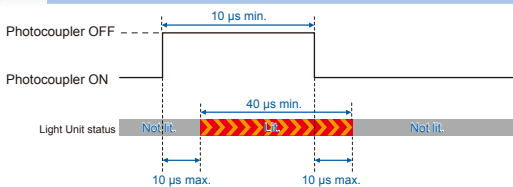

* The LED Light Unit will turn off by OFF signal sent by either trigger signal input or Ethernet communications.



● Trigger Logic Switch Set to LOW

The Light Units turn ON when the photocoupler is ON, and OFF when the photocoupler is OFF.

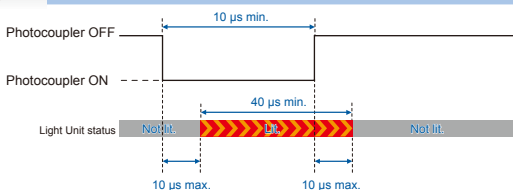

* The LED Light Unit will turn on by ON signal sent by either trigger signal input or Ethernet communications.

Strobe Mode



● Trigger Logic Switch Set to HIGH

From the point where the photocoupler goes OFF, the Light Units are turned ON for the set time (40 μ s to 40 ms).

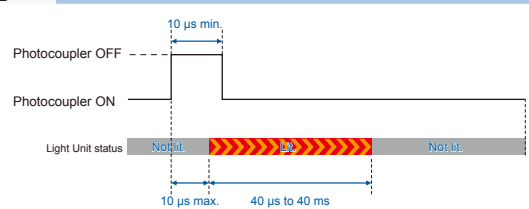

● Trigger Logic Switch Set to LOW

From the point where the photocoupler goes ON, the Light Units are turned ON for the set time (40 μ s to 40 ms).

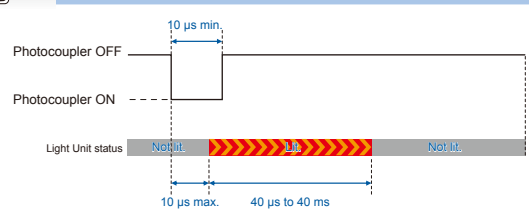

9 Troubleshooting

If the consumption current of Light Units exceeds 107% higher than the rated current, the overcurrent protection operates and stops the output. OCP will be displayed on the digital display.

Please check the rated current of Light Units and connect the Light Units under the rated current of this control unit.

Please press Setting Switch for over a second to reset the OCP error. (OCP error can be reset by rebooting.)



Error Output

When detecting the error during external control, command will be received as acknowledgement for checking status (over current confirmation) command "C".

* Immediately after the error, occurrence of an error will be noticed only one time by using UDP protocol. Notify data is the same as checking status (over current confirmation) command "C".

For details, refer to 7. *Control with External Signals*.

10 Main Specifications

| | |
|------------------------------------|---|
| Product name | Control Unit for LED Light Units |
| Model name | PD3-3024-3-ET(A) |
| Applicable Light Unit rating | 24 V, 28 W |
| PWM frequency | 125 kHz |
| Input voltage (rated) | 24 VDC |
| Input voltage (range) | 21.6 to 26.4 VDC |
| Power consumption (typ.) | 32W |
| Rated output voltage | 24 VDC |
| Rated output current | Total for 3 channels: 1.1 A |
| Operating temperature and humidity | Temperature: 0 to 40°C, Humidity: 20% to 85% (with no condensation) |
| Storage temperature and humidity | Temperature: -20 to 60°C, Humidity: 20% to 85% (with no condensation) |
| Vibration resistance | Acceleration: 19.6 m/s ² , Frequency: 10 to 55 Hz, Cycles: 3 minutes, Sweep cycle: For 1 hour each in X, Y, and Z directions |
| Cooling method | Natural air cooling |
| CE marking | EMC standard: Conforms to EN 61326-1 Class A |
| Input connector | 24 VDC input: 2-pin Terminal Block × 1 |
| Output connectors | Light output: SMP-03V-BC (J.S.T. Mfg. Co., Ltd.) × 3 |
| External control connector | Trigger input: MIL connector (MIL-C-83503 compliant), 10-pole For setting the light intensity and lighting mode: RJ-45 |
| Material and surface processing | Material: Aluminum and resin, Surface processing: Blue alumite |
| Weight | 400 g max. |
| Accessories | Instruction Guide |

11 Dimensions

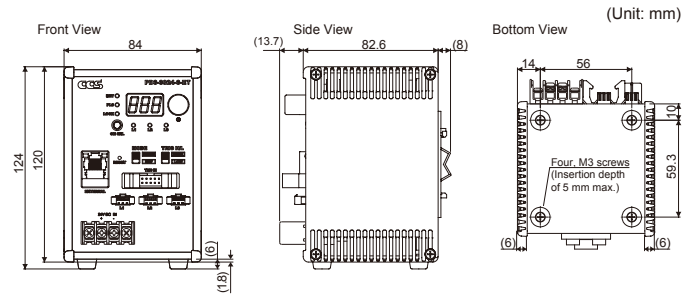

12 Optional Accessories (Sold Separately)

(Unit: mm)

External Trigger Input Cable

Model: EXCB2-M10-3

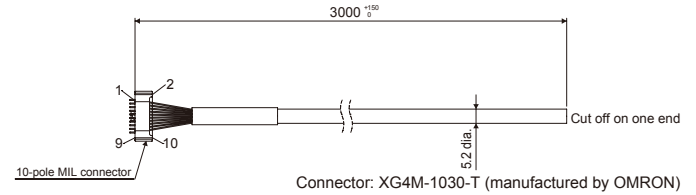

Base Brackets

Model: BK-PD3

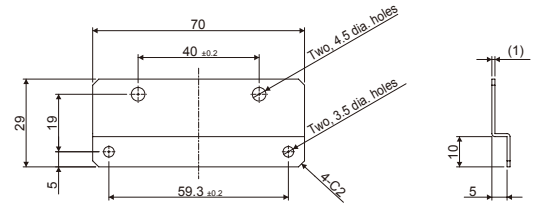

Includes two Base Brackets and four mounting screws

Do not use the product in the following situations.

- Under conditions or in an environment not described in this instruction guide.
- In nuclear energy control systems, railroad systems, aviation systems, vehicles, combustion equipment, medical equipment, amusement machines, or safety equipment.
- In applications involving serious risk to life or property, particularly applications demanding a high level of safety.

- Contents of this Instruction Guide may be changed without prior notice.
- Illustrations used in this Instruction Guide may differ from actual products.
- CCS maintains the copyright on this Instruction Guide. Unauthorized transfer or reproduction is strictly prohibited.