

LNSD-100BL-HU

Model Name	LNSD-100BL-HU
LED Color	Blue
Input Voltage	DC24V(max.)
Power Consumption	11W(max.)
Weight	200g
Input Connector	ELP-02V x 1 (~1200mm) ELP-02V x 2 (1300mm~)
Polarity & Signal	1: (+), 2: (-)

Unit: mm

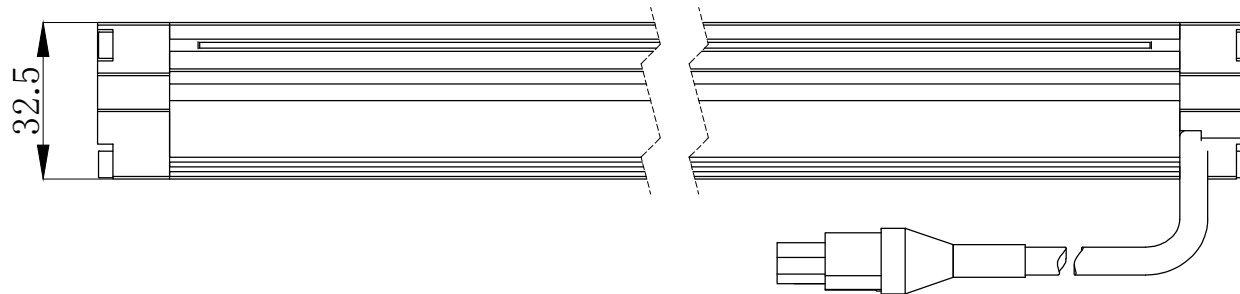
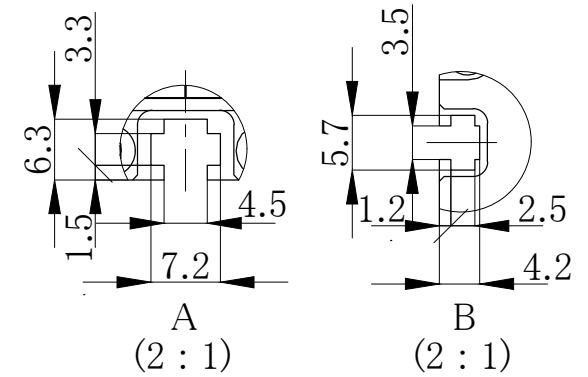
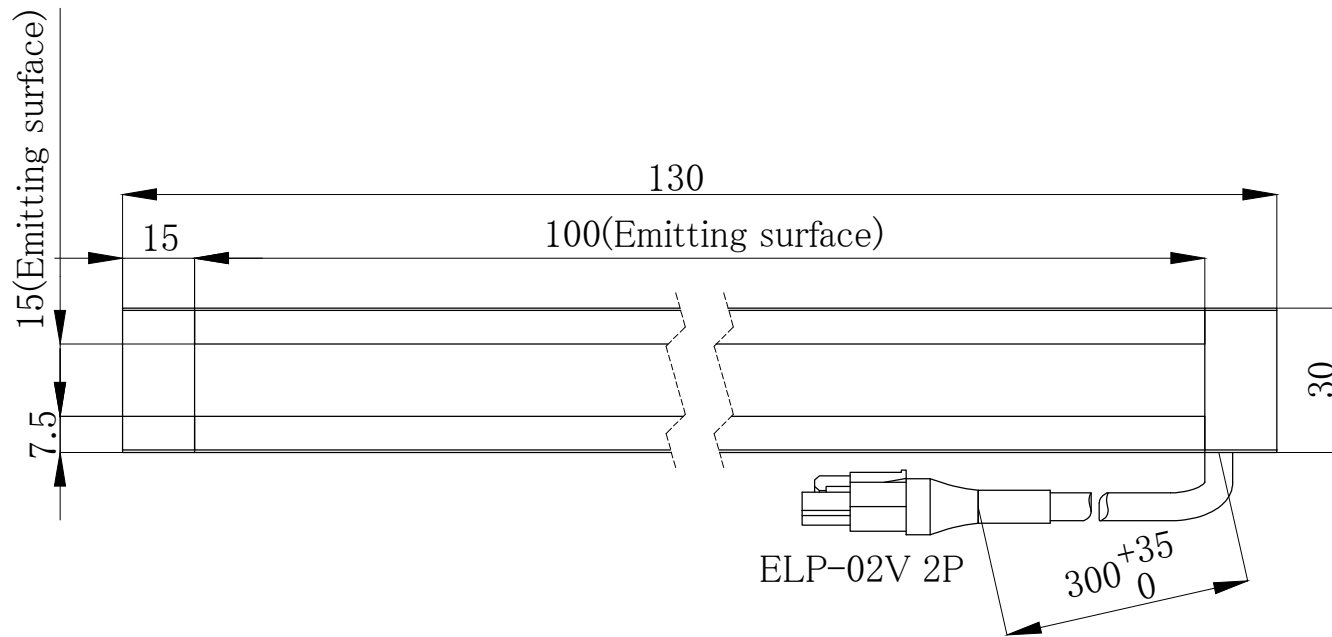

2xM3 Nut slot
(For installation)

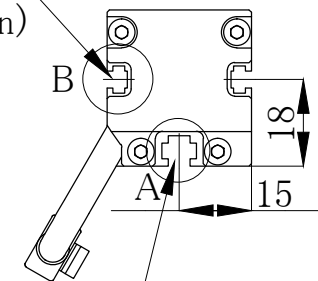

M4 Nut slot
(For installation)