

ML-3528-43M39

ML-FF series



Drawing No. A23294

レンズ形式	Lens Type	Line Scan Lens	
フォーカス位置	Focus Position	Infinity	1000(M.O.D)
光学倍率	Magnification	-	0.035
焦点距離 (mm)	Focal Length	35.33	35.33
Fno	Fno	2.80~22.00	
NA	Numerical Aperture	-	0.006
WD/OD (mm)	Working/Object Distance	-/-	1000.0 / 1014.0
O/I (mm)	Object to Image Distance	-	1106.16
鏡筒長 (mm)	Mechanical Tube Length	35.90	
レンズバック (mm)	Lens Back	26.30	27.53
被写界深度 (mm)	DOF @PCoC ϕ 0.04mm	-	197.365
分解能 (μ m)	Resolution @ λ =550nm	-	55.36
前側/後側主点位置 (mm)	Front/Rear Principal Position	28.97 / -8.95	28.97 / -8.95
入射/出射瞳位置 (mm)	Entrance/Exit Pupil Position	48.34 / -20.35	48.34 / -20.35
入射/出射瞳径 (mm)	Entrance/Exit Pupil Diameter	12.53 / 16.57	12.53 / 16.57
テレセントリック (deg.)	Telecentricity	32.488	31.824
光学ディストーション (%)	Optical Distortion	-0.695	-0.602
周辺光量比 (%)	Relative Illumination	26.16	27.53
質量 (g)	Weight	200.0	
マウント	Mount	M39x1	
イメージサークル径 (mm)	Image Circle	ϕ 43	
最大適合カメラ	Largest Compatible Camera	IF43	

ML-3528-43M39

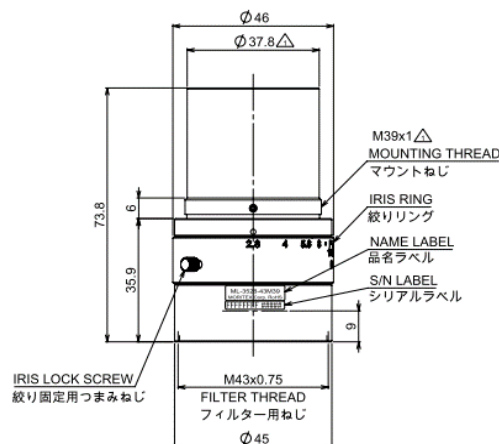

WD=Infinity Fno2.8

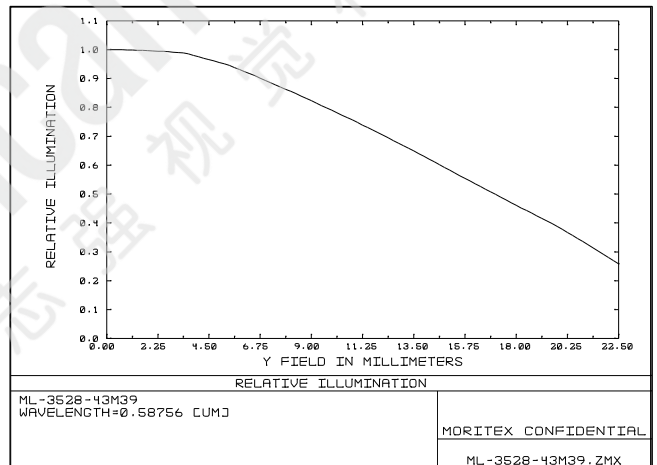
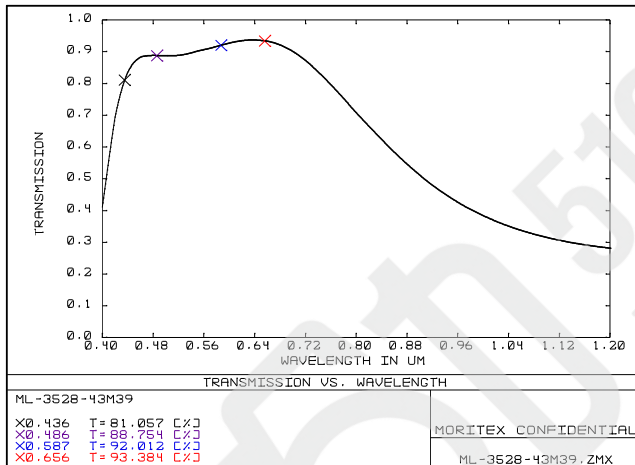
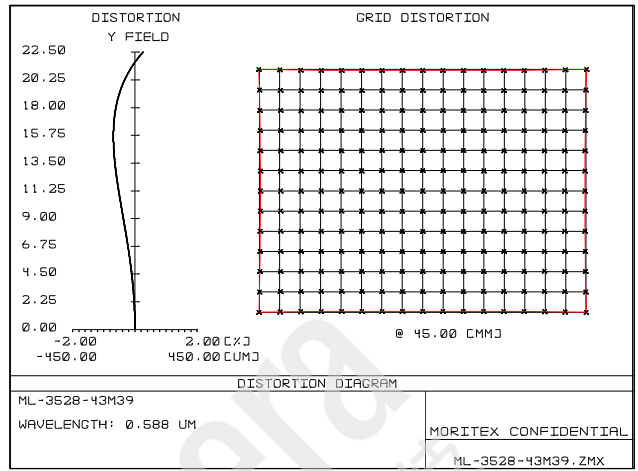
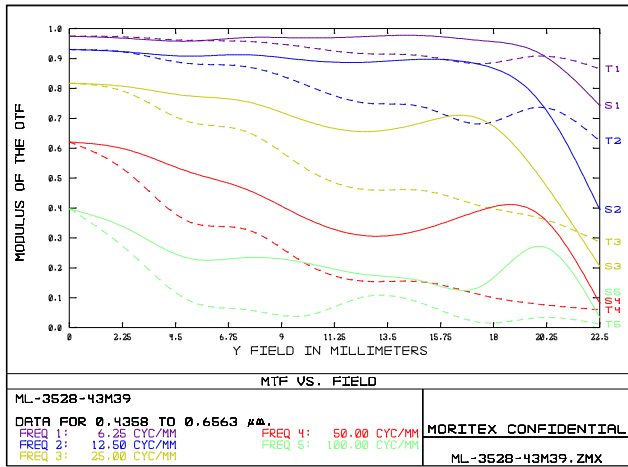

内容は、通知なしに随時変更されることがあります。

The content is subject to change at any time without notification.

0.035x Fno2.8

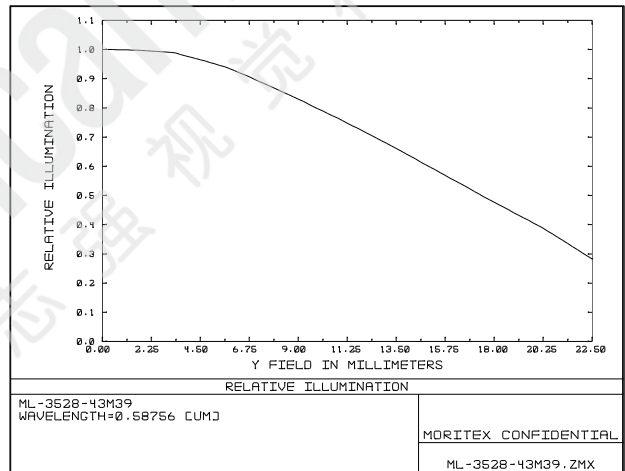
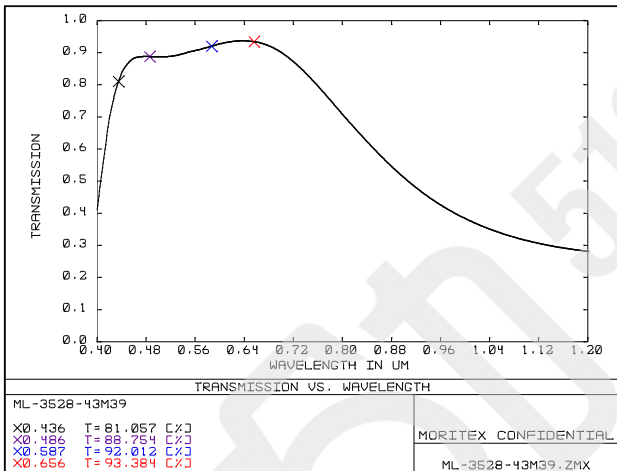
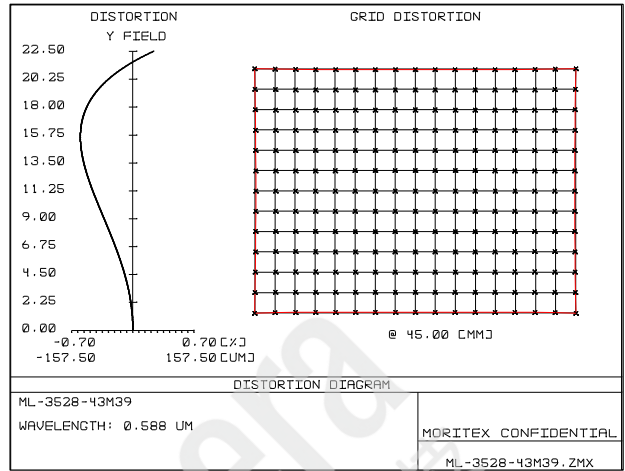
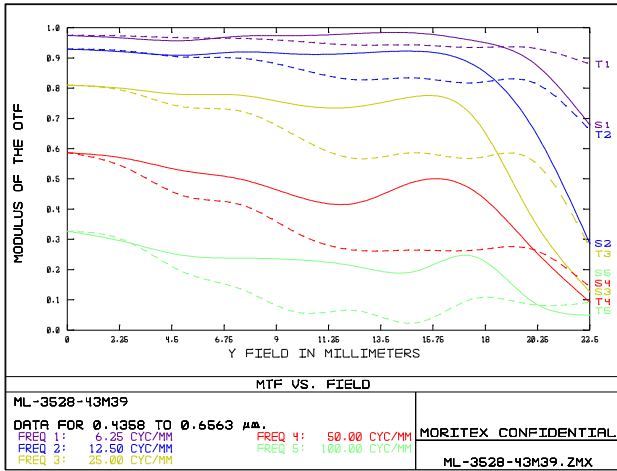

内容は、通知なしに随時変更されることがあります。
The content is subject to change at any time without notification.

株式会社 モリテックス MORITEX Corporation
 レンズ開発部
 Technology center Lens design & Development technology
 TEL +81 (0)48-218-2536 moritex.mvs@moritex.com
 FAX +81 (0)48-462-6713 www.moritex.com

