

ML-U0817SR-18C

ML-U-SR series



Drawing No. A23496

		Lens Type	CCTV Lens	
		Focus Position	Reference Magnification	M.O.D
		Magnification	0.026	0.067
	(mm)	Focal Length	8.14	7.98
Fno		Fno	1.74	16.00
NA		Numerical Aperture	-	-
WD/OD (mm)		Working/Object Distance	300.0 / 302.5	100.0 / 102.5
O/I (mm)		Object to Image Distance	391.33	195.38
	(mm)	Mechanical Tube Length	77.00	
	(mm)	Lens Back	11.36	11.29
	(mm)	DOF @PCoC 0.04mm	219.593	32.910
	(μ m)	Resolution @ $\lambda=550$ nm	-	-
/	(mm)	Front/Rear Principal Position	25.57 / 3.02	25.38 / 2.81
/	(mm)	Entrance/Exit Pupil Position	17.86 / -142.70	17.81 / -142.70
/	(mm)	Entrance/Exit Pupil Diameter	4.53 / 85.50	4.45 / 85.50
(deg.)	H x V	Angle Of View	85.02 x 68.35	86.40 x 69.53
TV	(%)	TV Distortion	-1.880	-2.151
	(%)	Relative Illumination	25.64	26.99
	(g)	Weight	244.2	
		Mount	C mount	
	(mm)	Image Circle	17.6	
		Largest Compatible Camera	1.1 Inch	

ML-U0817SR-18C

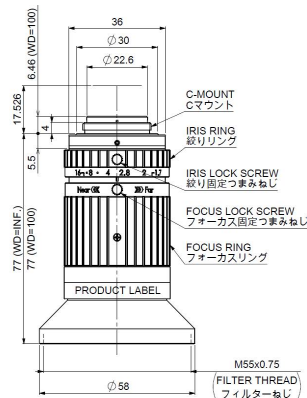

WD=300.0mm Fno2.8

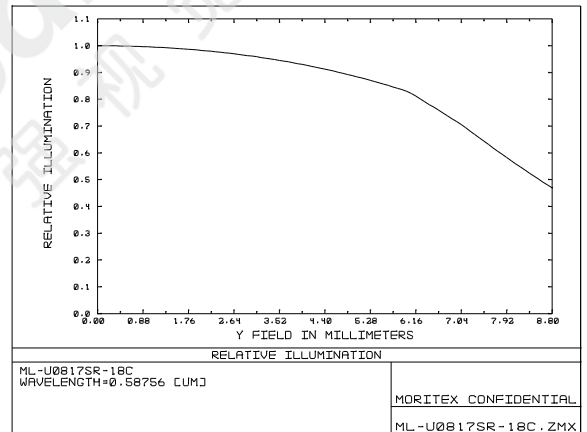
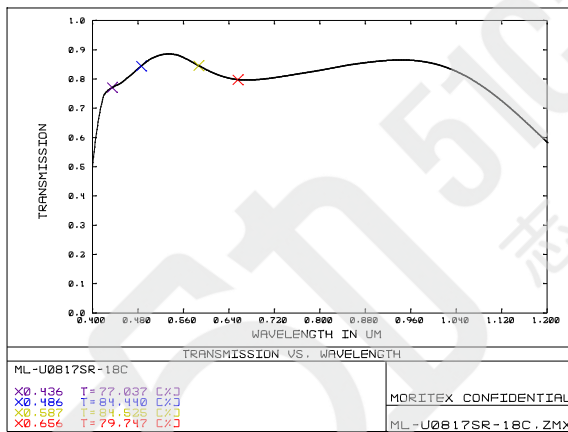
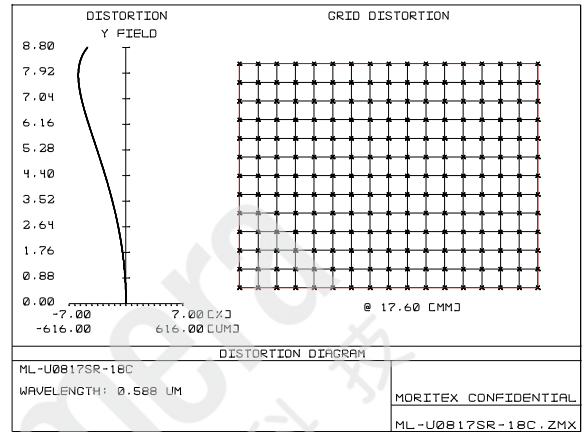
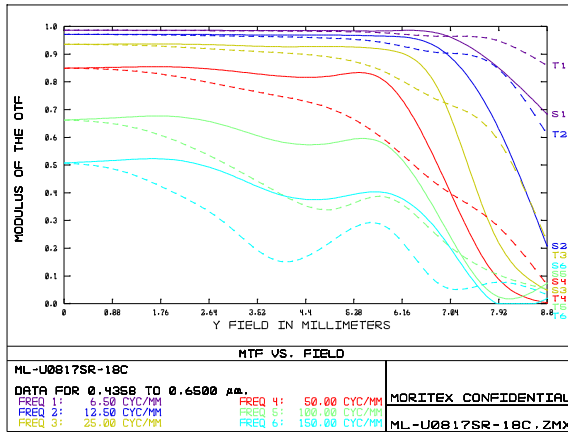

The content is subject to change at any time without notification.

株式会社 **モリテックス** MORITEX Corporation

Technology center Lens design & Development technology

TEL +81 (0)48-218-2536 moritex.mvs@moritex.com

FAX +81 (0)48-462-6713 www.moritex.com



WD=100.0mm Fno2.8

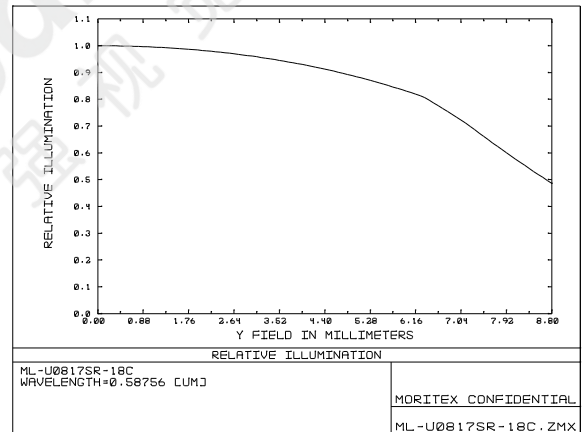
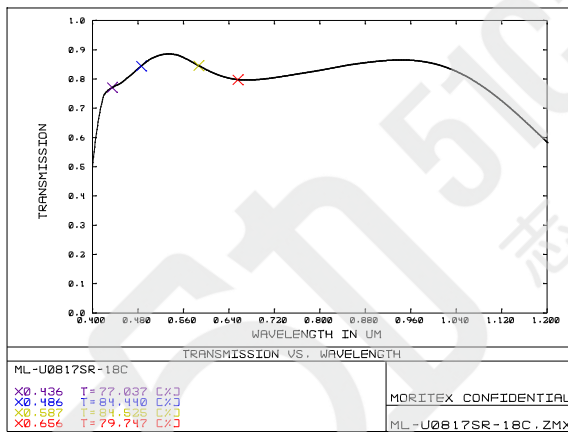
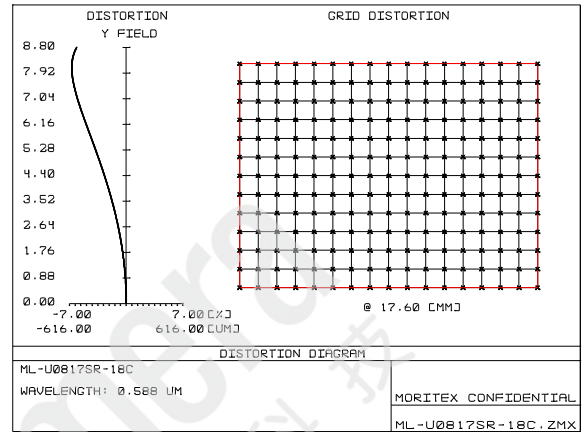
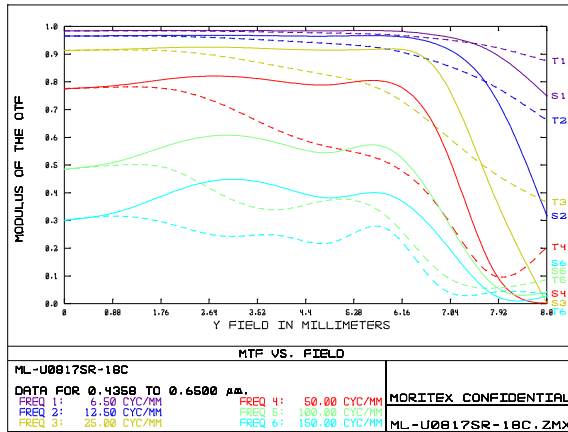

The content is subject to change at any time without notification.

株式会社 モリテックス MORITEX Corporation

Technology center Lens design & Development technology

TEL +81 (0)48-218-2536 moritex.mvs@moritex.com

FAX +81 (0)48-462-6713 www.moritex.com

