

# ML-M2516UR

## ML-M-UR series



Drawing No. A23044

		Lens Type	CCTV Lens	
		Focus Position	Reference Magnification	M.O.D
		Magnification	0.049	0.152
(mm)		Focal Length	25.00	25.00
Fno		Fno	1.60	16.00
NA		Numerical Aperture	-	-
WD/OD (mm)		Working/Object Distance	500.0 / 510.0	150.0 / 160.0
O/I (mm)		Object to Image Distance	553.34	205.92
(mm)		Mechanical Tube Length	34.60	38.50
(mm)		Lens Back	13.75	16.33
(mm)		DOF @PCoC 0.04mm	54.223	5.835
( $\mu$ m)		Resolution @ $\lambda=550$ nm	-	-
/	(mm)	Front/Rear Principal Position	29.42 / -12.46	29.42 / -12.46
/	(mm)	Entrance/Exit Pupil Position	18.48 / -31.94	18.48 / -31.94
/	(mm)	Entrance/Exit Pupil Diameter	15.92 / 28.32	15.92 / 28.32
(deg.)	H x V	Angle Of View	19.39 x 14.64	18.05 x 13.89
TV	(%)	TV Distortion	-0.041	-0.271
	(%)	Relative Illumination	49.78	53.52
(g)		Weight	50	
		Mount	C mount	
	(mm)	Image Circle	11	
		Largest Compatible Camera	2/3 Inch	

### ML-M2516UR

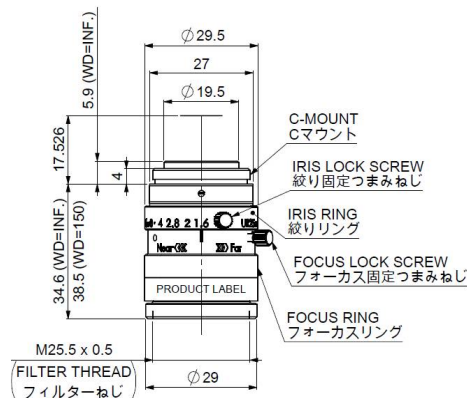

### WD=500.0mm Fno2.8

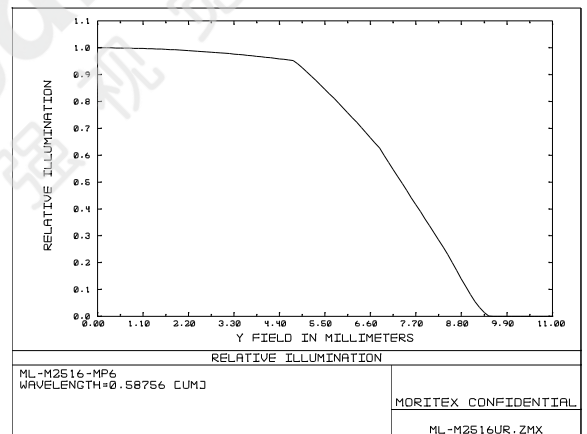
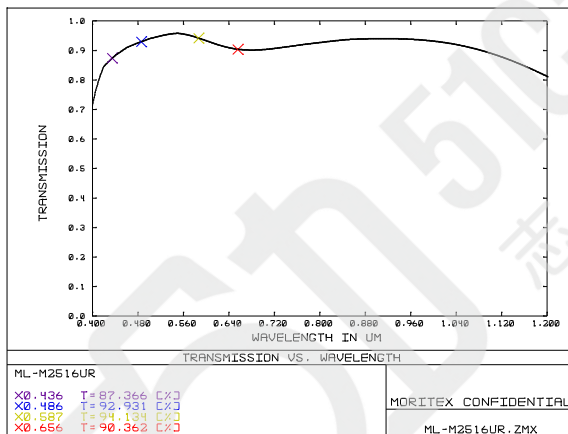
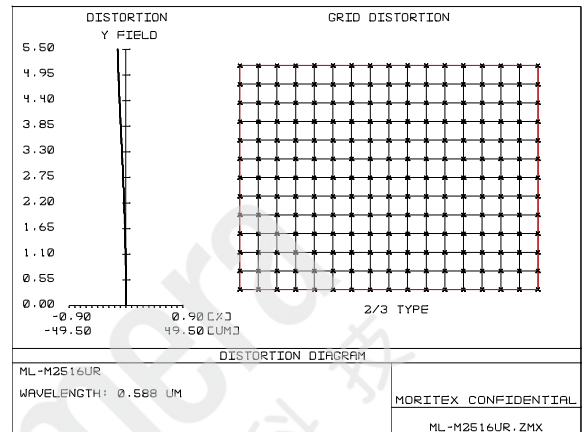
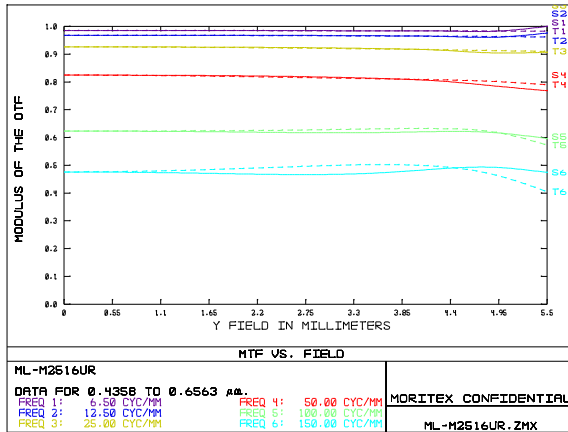

The content is subject to change at any time without notification.

株式会社 **モリテックス** MORITEX Corporation

Technology center Lens design & Development technology

TEL +81 (0)48-218-2536 moritex.mvs@moritex.com

FAX +81 (0)48-462-6713 www.moritex.com



**WD=300.0mm Fno2.8**

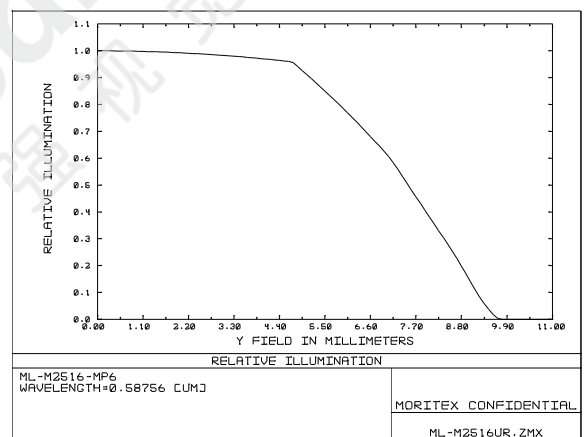
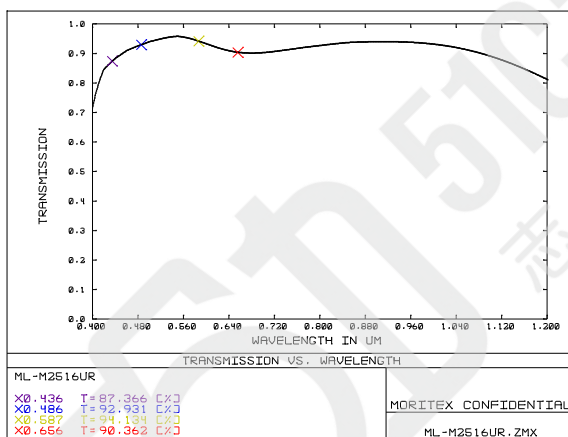
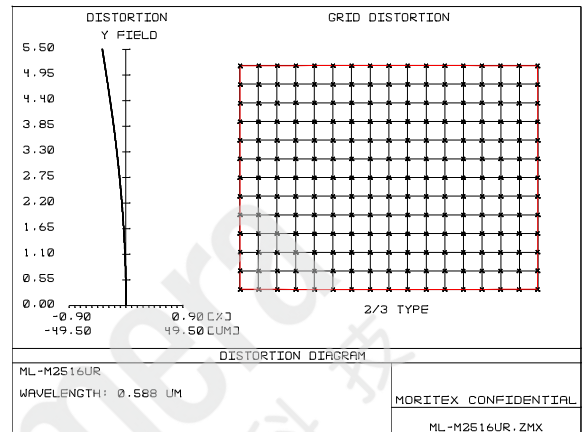
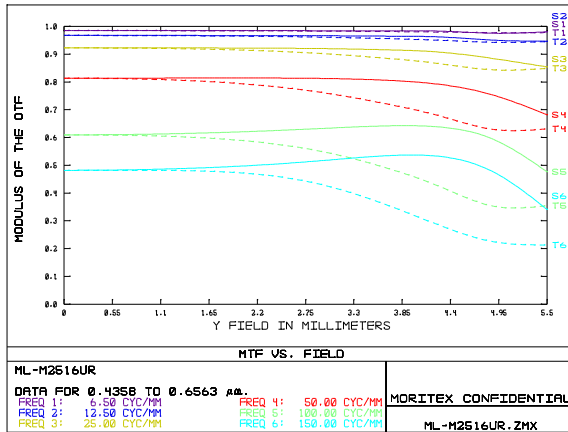

The content is subject to change at any time without notification.

**株式会社 モリテックス MORITEX Corporation**

Technology center Lens design & Development technology

TEL +81 (0)48-218-2536 moritex.mvs@moritex.com

FAX +81 (0)48-462-6713 www.moritex.com



**WD=150.0mm Fno2.8**

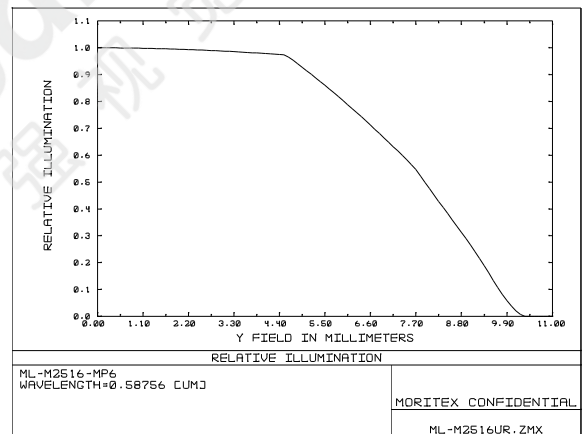
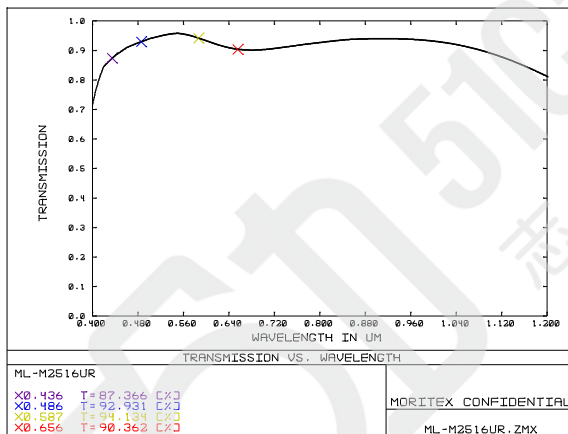
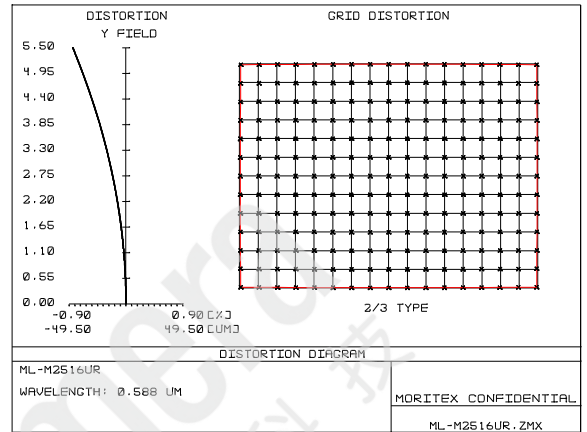
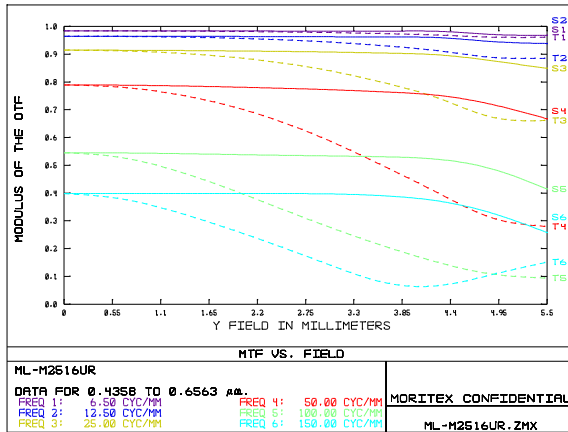

The content is subject to change at any time without notification.

**株式会社 モリテックス MORITEX Corporation**

Technology center Lens design & Development technology

TEL +81 (0)48-218-2536 moritex.mvs@moritex.com

FAX +81 (0)48-462-6713 www.moritex.com

