

# ML-M1616UR

## ML-M-UR series



Drawing No. A23072

		Lens Type	CCTV Lens	
		Focus Position	Reference Magnification	M.O.D
		Magnification	0.031	0.095
(mm)		Focal Length	16.16	16.16
Fno		Fno	1.60	16.00
NA		Numerical Aperture	-	-
WD/OD (mm)		Working/Object Distance	500.0 / 507.0	150.0 / 157.0
O/I (mm)		Object to Image Distance	554.26	205.30
(mm)		Mechanical Tube Length	35.50	37.00
(mm)		Lens Back	12.16	13.20
(mm)		DOF @PCoC 0.04mm	131.893	14.387
( $\mu$ m)		Resolution @ $\lambda=550$ nm	-	-
/ (mm)		Front/Rear Principal Position	28.44 / -4.50	28.44 / -4.50
/ (mm)		Entrance/Exit Pupil Position	18.85 / -28.07	18.85 / -28.07
/ (mm)		Entrance/Exit Pupil Diameter	10.18 / 25.02	10.18 / 25.02
(deg.)	H x V	Angle Of View	30.37 x 22.92	29.62 x 22.39
TV (%)		TV Distortion	-0.472	-0.674
(%)		Relative Illumination	32.75	36.61
(g)		Weight	50	
		Mount	C mount	
(mm)		Image Circle	11	
		Largest Compatible Camera	2/3 Inch	

### ML-M1616UR

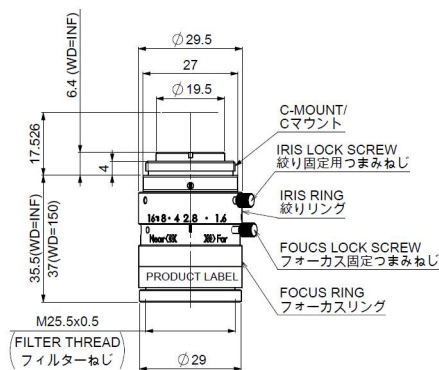

**WD=500.0mm Fno2.8**

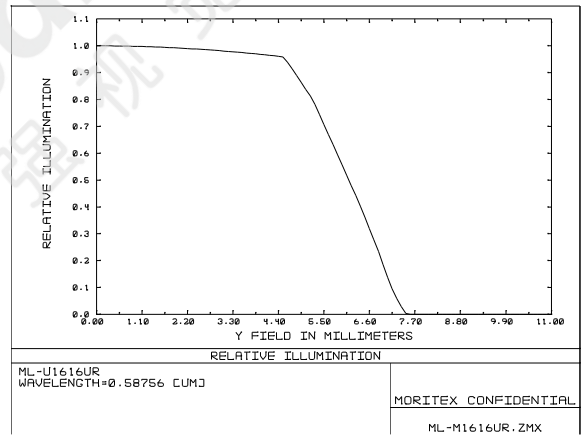
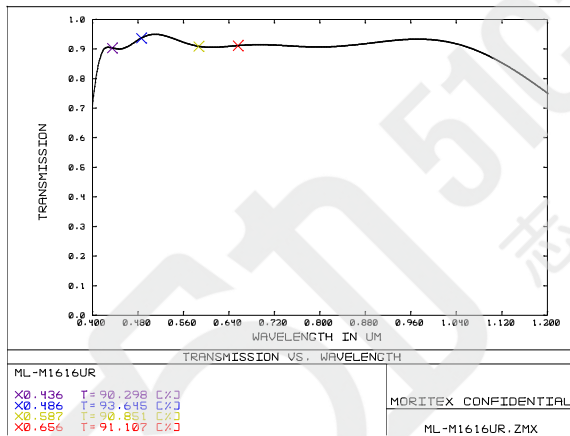
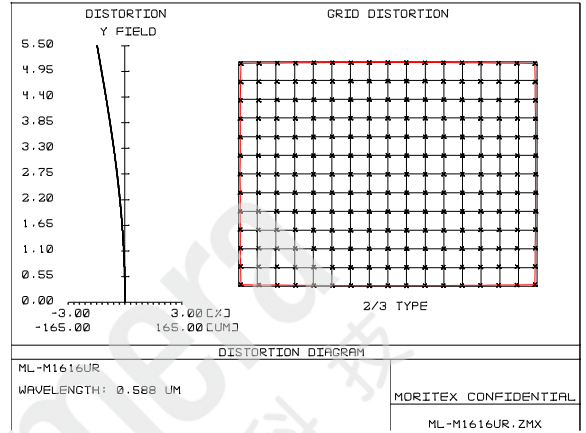
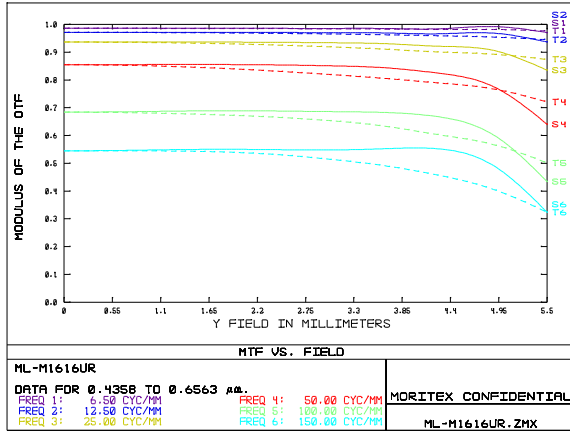

The content is subject to change at any time without notification.

**株式会社 モリテックス MORITEX Corporation**

Technology center Lens design & Development technology  
 TEL +81 (0)48-218-2536 moritex.mvs@moritex.com  
 FAX +81 (0)48-462-6713 www.moritex.com



### WD=300.0mm Fno2.8

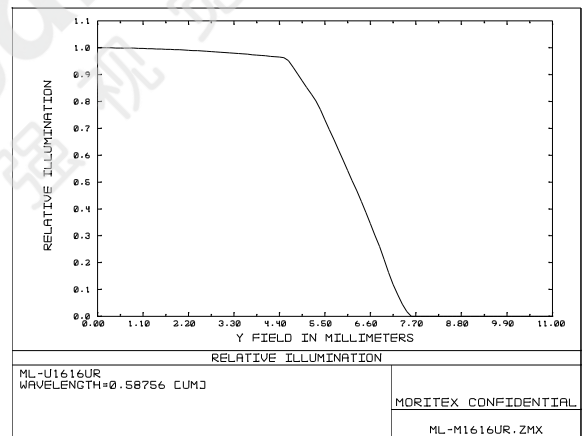
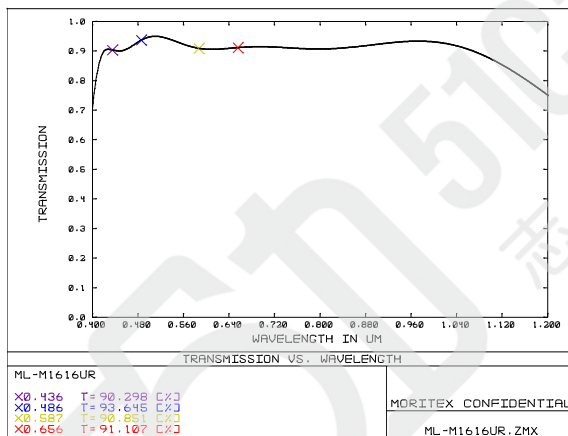
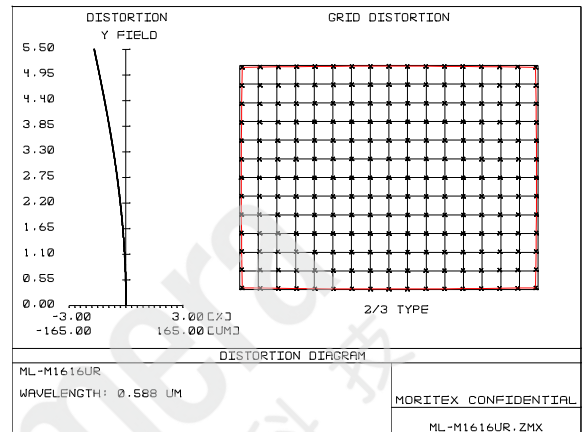
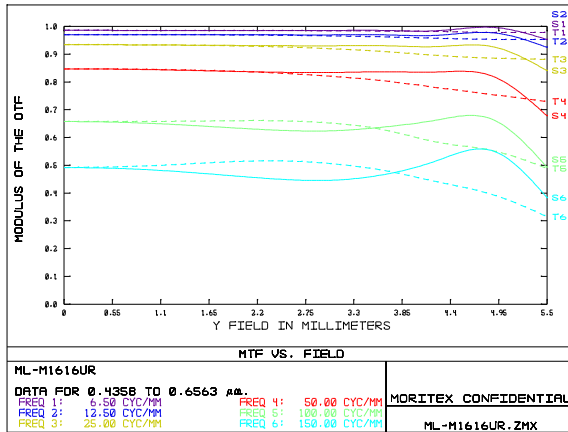

The content is subject to change at any time without notification.

株式会社 **モリテックス** MORITEX Corporation

Technology center Lens design & Development technology

TEL +81 (0)48-218-2536 moritex.mvs@moritex.com

FAX +81 (0)48-462-6713 www.moritex.com



### WD=150.0mm Fno2.8

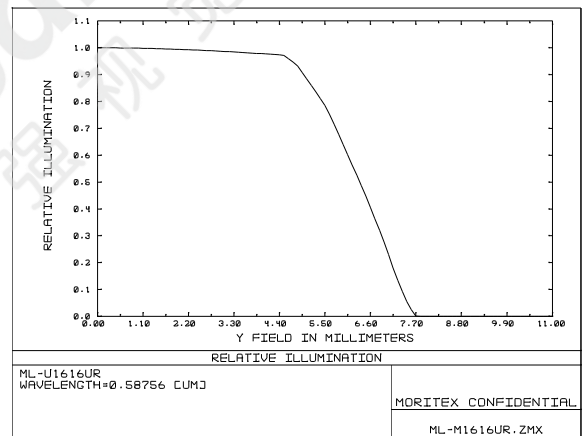
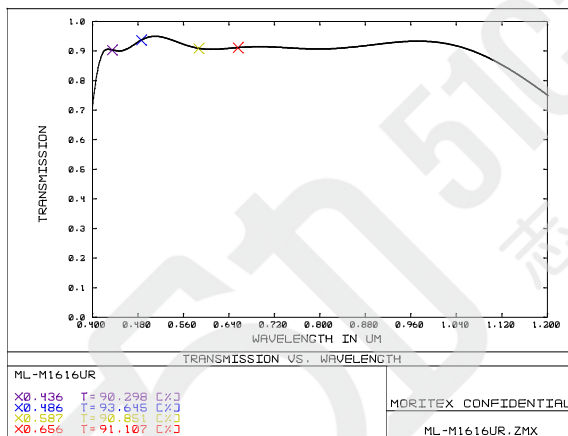
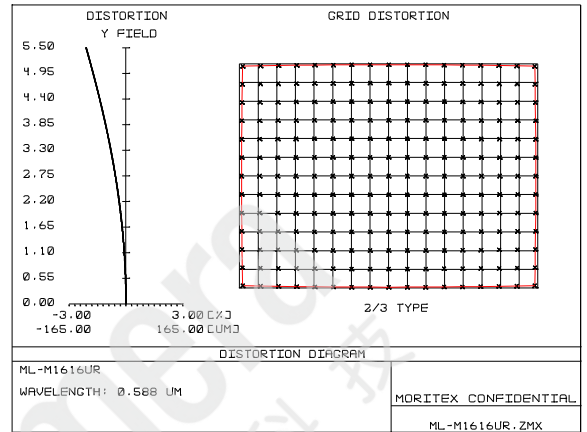
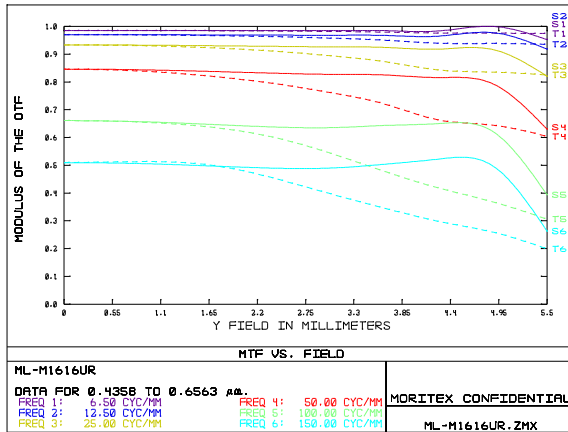

The content is subject to change at any time without notification.

株式会社 **モリテックス** MORITEX Corporation

Technology center Lens design & Development technology

TEL +81 (0)48-218-2536 moritex.mvs@moritex.com

FAX +81 (0)48-462-6713 www.moritex.com

