

## Linea™ HS Multifield

16k Multi-array CMOS TDI Camera

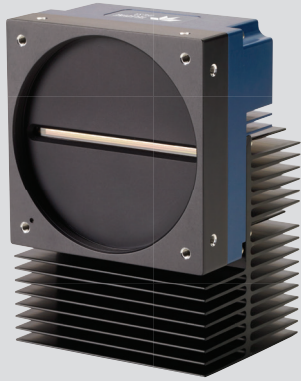

### Key Features

- » Capture three field images simultaneously in a single scan
- » High speed 133 kHz x 3
- » High sensitivity multi-array TDI
- » Bi-directionality
- » Assisted alignment marks

### Programmability

- » Multiple Regions of Interest for calibration, data reduction
- » 8 or 12 bit output
- » Flat field and lens shading correction
- » Programmable coefficient sets

### Typical Applications

- » Flat panel display inspection
- » Printed circuit board inspection
- » Semiconductor wafer
- » Life sciences
- » Web inspection
- » General purpose machine vision

## Industry's First Multifield TDI Camera with High Throughput and Detectability

Based on Teledyne DALSA's industry leading CMOS TDI technology, the new Linea HS Multifield™ camera is the most advanced TDI product in the marketplace. This camera delivers the highest performance available, with unique features that significantly improve detectability for many demanding applications. The camera comes with high-speed fiber optic interface, delivering up to 8.4 Gigapixels per second over a single and long length fiber optic cable.

### Multifield Technology

Multifield is a new imaging technology that enables capturing multiple images simultaneously using various lighting conditions (e.g. brightfield, darkfield, and backlight) in a single scan.

Teledyne DALSA's Linea HS Multifield camera is the first in the industry capable of capturing up to three images using light sources at different wavelengths. The camera uses advanced wafer-level coated dichroic filters with minimum spectral crosstalk to spectrally isolate three images captured by separate TDI arrays. It can be used for color imaging as well.

This new technology significantly improves inspection speeds and image quality, as it eliminates the need for multiple scans. The difference between traditional color imaging and multifield imaging is the filter technology. Conventional color filters have significant spectral crosstalk between RGB channels, while the multifield filters have minimum spectral crosstalk.

### Specifications

Resolution	16,384 x 256 pixels
Line rate	133 kHz x 3
Pixel Size	5 x 5 μm
Bit depth	8 or 12 bit selectable
Lens Mounts	M90 x 1
Responsivity	See graph
Dynamic Range	69 dB
Nominal Gain Range	1x to 10x
Size	97 x 140.5 x 78.6 mm
Mass	1200 g
Operating Temp	0 to +60 °C (front plate)
Power Supply	+12 to +24 VDC
Power Dissipation	28 W
Data and Control	Camera Link HS CX4
GPIO	Hirose 12-pin
Regulatory Compliance	CE, FCC, RoHS

### Camera Models

Part Number	Resolution	Max. Line Rate	Pixel Size	Output
HL-HF-16K13T-00-R	16,384 x (64 +128 + 64)	133 kHz x 3	5 x 5 μm	F1, F2, F3

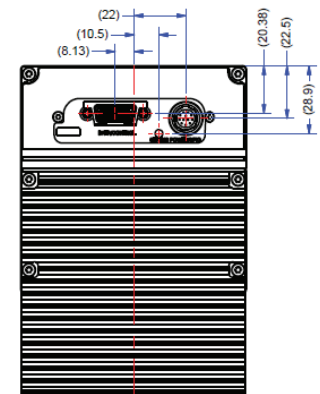
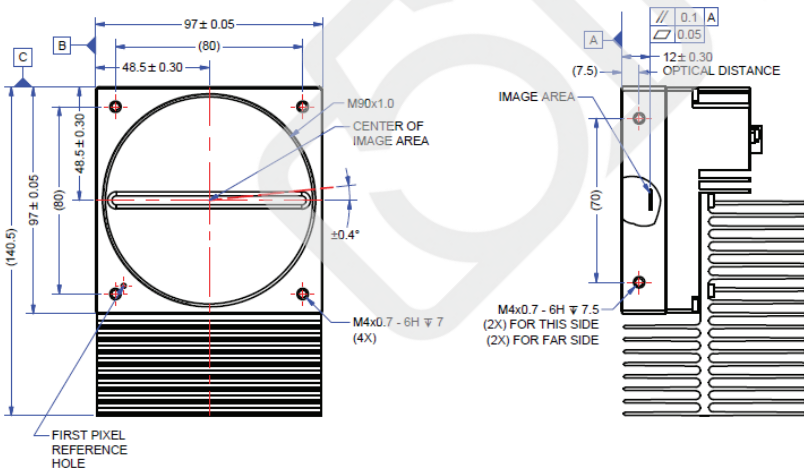
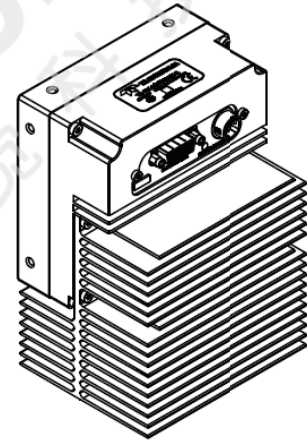
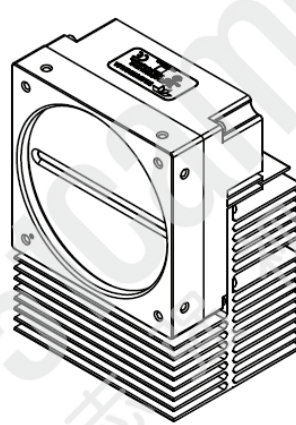
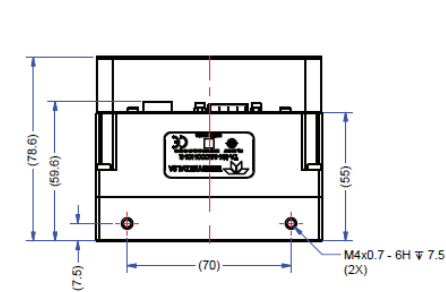
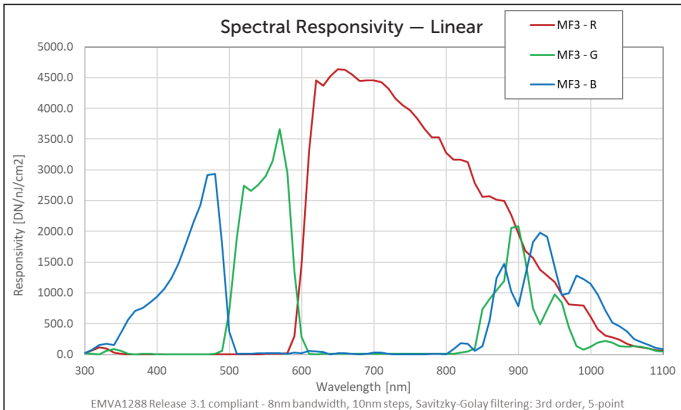

NOTES:  
1. UNITS: MILLIMETERS.  
2. IMAGE AREA IS ALIGNED TO DATUMS **A**, **B** & **C**.

**Americas**

Boston, USA  
+1 978-670-2000  
sales.americas@teledynedalsa.com

**Europe**

Krailling, Germany  
+49 89-89-54-57-3-80  
sales.europe@teledynedalsa.com

**Asia Pacific**

Tokyo, Japan  
+81 3-5960-6353  
sales.asia@teledynedalsa.com

Shanghai, China  
+86 21-3368-0027  
sales.asia@teledynedalsa.com