

Genie™ NanoXL-M4090

Area Scan Monochrome Cameras



Key Features

- Uses standard PC Ethernet port & hardware
- Supports cable lengths up to 100 m (CAT-5e or CAT-6)
- Simplified set-up with field proven Sapera Essential software featuring CamExpert
- Engineered to accommodate industrial environment with a Ruggedize, screw mount, RJ-45 connector

Programmability

- Higher frame rates achievable in partial scan mode
- Global electronic shutter with exposure Control
- Multi-Exposure Feature
- Multi-ROI Feature

Typical Applications

- Electronics manufacturing inspection
- Industrial metrology
- Intelligent traffic systems

Regulatory Compliance

- CE, FCC and RoHS

Overview

Compact GigE Vision camera with very high resolution.

The Genie NanoXL-M4090 offers the On-Semi Python 16K Monochrome version sensor with a resolution of 4096 x 4096. Teledyne DALSA's "Burst Acquisition" and "Turbo Drive" feature allows for image capture rates of 30 fps in 16 Mpixels resolution while maintaining very good image quality. The Genie NanoXL-M4090 takes advantage of gigabit Ethernet technology, transmitting data over standard CAT-5e and CAT-6 cables to distances of up to 100 m. Like all Teledyne DALSA GigE cameras, the Genie NanoXL-M4090 is based on AIA (Automated Imaging Association) GigE Vision Standard to directly link the camera to a PC.



Specifications

Active Resolution	4096 x 4096
Acquisition Frame Rate	30 fps (internal BurstMode)
Data Output Transfer	Gigabit Ethernet (1000 Mbit/s) only
Pixel Size	4.5 μm x 4.5 μm
Data Format	8 Bits output
Exposure Control	Automatic, Programmable, or via External Trigger
Dynamic Range	55.2 dB
Gain Control	Automatic, Manual up to 3.17x analog gain
I/O Ports	2 opto-isolated input, 3 opto-isolated output
Image Buffer	500 MB of On-board memory
Lens Mount	M42 mount
Size (L x H x W)	30 mm x 59 mm x 59 mm (without lens adapter or connectors)
Mass	~163g
Operating Temp	-20 to +60c (Housing temperature)
Power Supply	10 to 36V or Power Over Ethernet (POE)
Power Dissipation	6.5 Watt @ 24Volt Aux.
Data Connector	Standard or Screw mount RJ-45
Power and I/O Connector	SAMTEC TFM-105 type
Camera Specification	GigE Vision v1.2 Compliant
Software Platform	Teledyne DALSA Sapera LT 8.0 or 3rd Party Genicam Compliant SDK
Part Number	G3-GM30-M4095 (Standard Response Model)

Genie™ NanoXL-M4090

Area Scan Monochrome Cameras

All Genie cameras feature value added functionality designed specifically for imaging and machine vision applications. All features are easily accessible with Teledyne DALSA's advanced software tools. These tools deliver superior image capture, performance, and control.

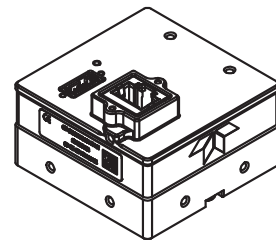
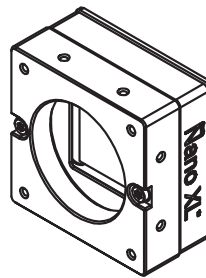
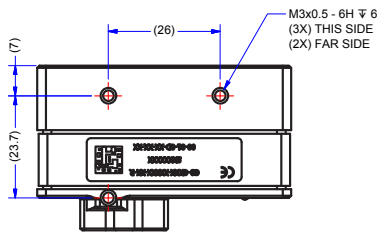
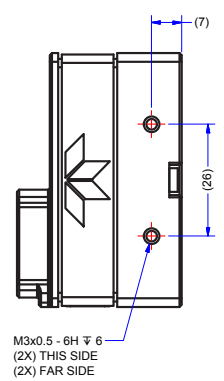
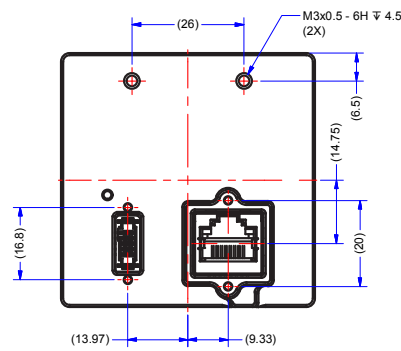
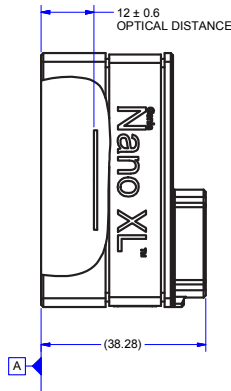
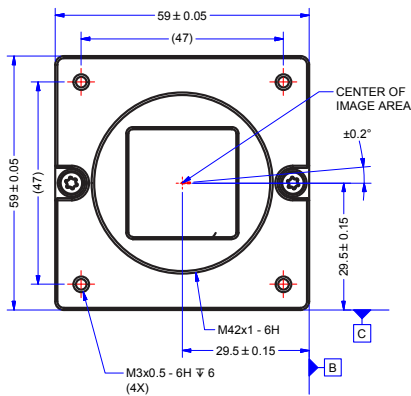
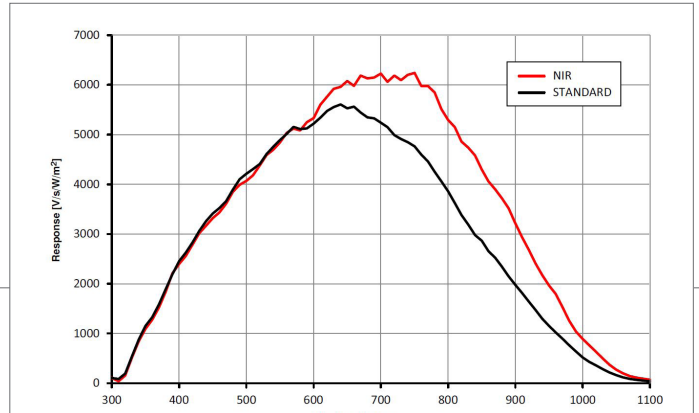

www.teledynedalsa.com

Americas

Boston, USA
+1 978-670-2000
sales.americas@teledynedalsa.com

Europe

Krailling, Germany
+49 89-89-54-57-3-80
sales.europe@teledynedalsa.com

Asia Pacific

Tokyo, Japan
+81 3-5960-6353
sales.asia@teledynedalsa.com

Shanghai, China
+86 21-3368-0027
sales.asia@teledynedalsa.com

Teledyne DALSA has its corporate offices in Waterloo, Canada
Teledyne DALSA reserves the right to make changes at any time without notice. Teledyne DALSA © 2016.

